

JLBIDW 901 compact dishwasher

Instruction manual

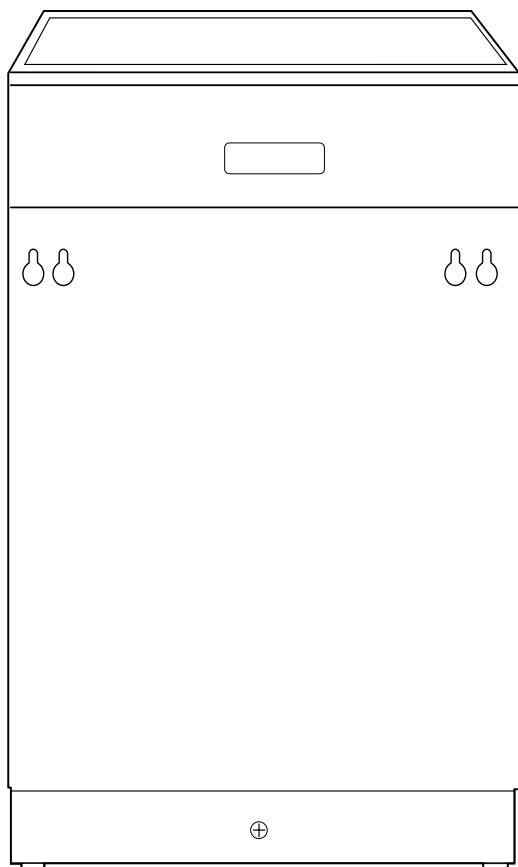

John Lewis



Important Safety Information

It is most important that this instruction book should be retained with the appliance for future reference. Should the appliance be sold or transferred to another owner, or should you move house and leave the appliance, always ensure that the book is supplied with the appliance in order that the new owner can get to know the functioning of the appliance and the relevant warnings. These warnings have been provided in the interest of your safety. You **MUST** read them carefully before installing or using the appliance. If you are unsure of the meanings of these warnings contact the John Lewis branch from which you purchased the appliance

Installation

- This appliance is heavy. Care should be taken when moving it.
- Check your dishwasher for any transport damage. Never connect a damaged machine. If your dishwasher is damaged, you should contact the John Lewis branch from which you purchased it.
- For safety reasons it is dangerous to alter the specifications or attempt to modify this product in any way.
- Any electrical and plumbing work required to install this appliance should be carried out by a qualified and competent person.
- Care must be taken to ensure that the appliance does not stand on the electrical supply cable.
- The sides of the dishwasher must never be drilled to prevent damage to hydraulic components.

Child safety

- This appliance is designed to be operated by adults.
- Children should not be allowed to tamper with the controls or play with the product.
- Ensure the packaging materials for this appliance are kept away from children so as to prevent the risk of injury or suffocation.
- The water in your dishwasher is not for drinking. Detergent residues may still be present in your machine. Keep children well away from your dishwasher when the door is open.
- Keep all detergents in a safe place out of children's reach.

Use

- Items that are contaminated by petrol, paint, steel or iron debris, corrosive, acidic or alkaline chemicals must not be washed in this dishwasher.
- Under no circumstances should you open the door whilst the appliance is in operation, especially during the washing phase, hot water may escape. However, if the door is opened, a safety device ensures that the machine stops.

- Only use products (detergent, salt and rinse aid) specifically designed for use in dishwashers.
- Long bladed knives stored in an upright position are a potential hazard.
- Long and/or sharp items of cutlery such as carving knives must be positioned horizontally in the upper basket.
- Ensure that the door of the dishwasher is always closed when it is not being loaded or unloaded. In this way you will avoid anybody tripping over the open door and hurting themselves.
- When finishing loading or unloading close the door, as an open door can be a hazard.
- Do not sit or stand on the open door.
- Isolate the appliance from the power supply and turn off the water supply after use.

Maintenance and cleaning

- For information on maintenance and cleaning your dishwasher see page 23 of this Instruction manual.

Service

- This product should be serviced by an authorised service engineer, and only genuine spare parts should be used.



Environmental information

Dispose of the dishwasher packaging material correctly.

All packaging materials can be recycled.

Plastic parts are marked with standard international abbreviations:

- >PE< for polyethylene, e.g. sheet wrapping material.
- >PS< for polystyrene, e.g. padding material (always CFC-free).
- >POM< for polyoxymethylene, e.g. plastic clips.

Cardboard packaging is manufactured from recycled paper and should be deposited in the waste paper collection for recycling. As and when you cease to use your dishwasher and withdraw it from service, you should render it unserviceable before having it disposed of.



Warning! Children at play could lock themselves in your dishwasher or otherwise endanger their lives. Therefore cut off the power supply cable and make the door closing device unusable to prevent children from being trapped inside.

For the disposing of the appliance please take it to a recycling centre or to your dealer who may, for a small contribution to the costs, dispose it for you.

Please note: A cut off plug inserted into a 13 amp socket is a serious safety (shock) hazard. Please ensure the cut off plug is disposed of safely.

The symbol  on the product or on its packaging indicates that this product may not be treated as household waste. Instead it shall be handed over to the applicable collection point for the recycling of electrical and electronic equipment. By ensuring this product is disposed of correctly, you will help prevent potential negative consequences for the environment and human health, which could otherwise be caused by inappropriate waste handling of this product.

For more detailed information about recycling of this product, please contact your local city office, your household waste disposal service or the shop where you purchased the product.



Ecological hints

To save water and energy and help protect the environment, we recommend that you follow these hints:

- Ensure that the water softener is correctly adjusted.
- Do not pre-wash under running water.
- Select the wash programme to suit the nature and degree of the soiling on the dishes.
- Do not use more detergent, dishwasher salt and rinse aid than is recommended in these operating instructions and by the manufacturer of the respective product.
- **Delay start:** Control when your dishwasher begins the wash, to enable, for example, the use of economical overnight electricity tariffs.
- **Automatic Wash Programme:** This machine is fitted with a turbidity sensor which intelligently adjusts the temperature and rinsing cycles during the wash programme, depending on the degree of soiling on the dishes. This helps to reduce energy and water consumption on lightly soiled loads.

Contents

For the user

Important Safety Information	2
Installation	2
Child safety	2
Use	2
Maintenance and cleaning	2
Service	2
Ecological information	3
Environmental hints	3
Contents	4
Description of the Appliance	5
The Control Panel	9
Multi-tab function	10
Audible signals	11
When the Dishwasher is first installed	12
The water softener	12
Dishwasher salt and replenishment	13
Rinse aid and replenishment	14
Using the dishwasher	15
Loading cutlery and dishes	15
The lower basket	16
The cutlery basket	16
The upper basket	17
Adjusting the height of the upper basket	17
Use of detergent	18
Different kinds of detergent	19
Washing Programmes	20
Starting a Washing Programme	21
Maintenance and Cleaning	23
External cleaning	23
Cleaning the filters	23
Prolonged periods of non-operation	23
Frost precautions	23
Moving the machine	23
Something Not Working	24
Repairs - After Sales Service	26
Spare Parts	26

For the installer

Installation	6
Technical specifications	6
Electrical connection	6
Permanent connection	7
Water supply connections	7
Water inlet hose with safety valve	7
Water outlet hose connection	8
Building-in	8
Levelling	8
Fixing to the adjacent units	8

Guide to use the instruction manual

The following symbols will be found in the text to guide you throughout the instructions



Safety instructions



Hints and tips



Environmental information



This appliance complies with the following E.E.C. Directives:

- * 73/23 or 19.2.73 (Low Voltage Directive) and subsequent modifications;
- * 89/336 or 3.5.89 (Electromagnetic Compatibility Directive) and subsequent modifications.

Description of the Appliance

1. Upper basket stop
2. Water hardness dial
3. Salt container
4. Detergent dispenser
5. Control panel
6. Rating plate
7. Rinse aid dispenser
8. Filters
9. Lower spray arm
10. Upper spray arm
11. Upper basket

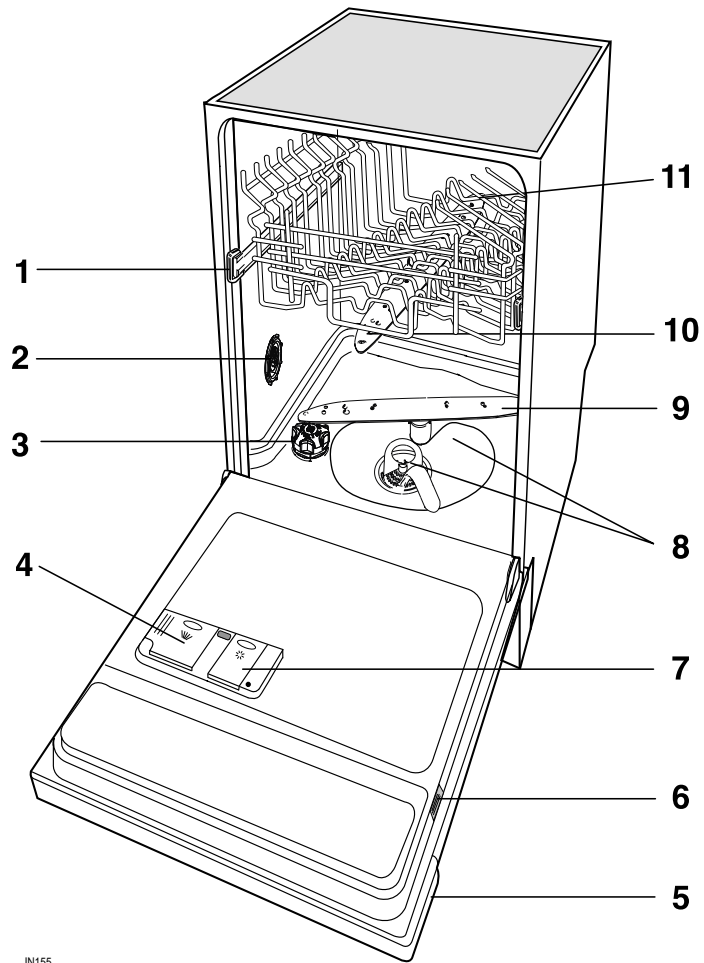

IN155

Installation

Technical specifications

Dimensions	Width	44.6 cm
	Height	81.8 - 87.8 cm
	Max depth	55.5 cm
	Max depth with open door	114 cm
Electrical connection: Voltage Overall power Fuse	Information on the electrical connection is given on the rating plate on the inner edge of the dishwasher's door.	
Water supply pressure	Minimum	0,05 MPa (0,5 bar)
	Maximum	0,8 MPa (8 bar)
Capacity	9 place settings	

Electrical connection

Any electrical work required to install this appliance should be carried out by a qualified electrician or competent person.



WARNING: THIS APPLIANCE MUST BE EARTHED.

The manufacturer declines any liability should this safety measure not be observed.

Before switching on, make sure the electricity supply voltage is the same as that indicated on the appliance's rating plate. The rating plate is located on the side of the dishwasher's door.

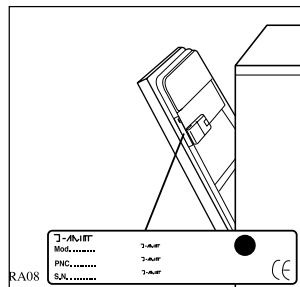

The plug moulded onto the lead incorporates a 13amp BSI362 fuse. Only ASTA or BSI fuses should be used.

To isolate the dishwasher from mains, remove the mains plug.

If the plug that is fitted to your appliance is not suitable for the socket, it must be cut off and the appropriate plug fitted.

Important

The wires on the mains lead are coloured in accordance with the following code:

Green and Yellow - Earth
Blue - Neutral
Brown - Live

If you fit your own plug, the colours of the wires in the mains lead of your appliance may not correspond with the markings identifying the terminals in your plug.

Proceed as follows:

1. Connect the Green and Yellow (earth) wire to the terminal in the plug which is marked with the letter "E" or the earth symbol \oplus or coloured green and yellow.
2. Connect the Blue (neutral) wire to the terminal in the plug which is marked with the letter "N" or coloured black.
3. Connect the Brown (live) wire to the terminal in the plug which is marked with the letter "L" or coloured red.
4. Upon completion there must be no cut, or stray strands of wire present and the cord clamp must be secure over the outer sheath.

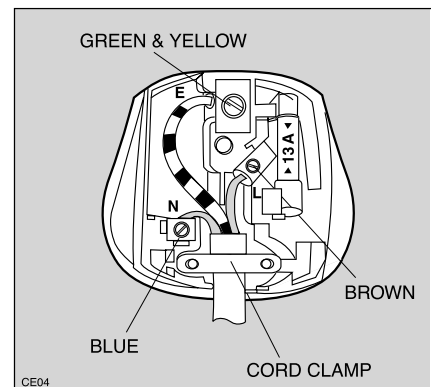

The plug must not be used if the fuse cover/carrier is lost. The cover/carrier is indicated by the coloured insert at the base of the plug.

A replacement cover/carrier must be obtained from your local Service Force centre. Please contact our extended warranty administrators on 0870 0107887 who will give you details for your local Service Force centre.

**WARNING:**

A cut off plug inserted into a 13 amp socket is a serious safety (shock) hazard. Ensure that the cut off plug is disposed of safely.

The plug must still be accessible after the appliance has been installed.



The appliance should not be connected to the electrical supply by means of an extension cable.

In case that the electrical cable has to be replaced, please contact our extended warranty administrators on 0870 0107887 who will give you details for your local Service Force repair agent.

**Important!**

If the mains supply cable is damaged it must be replaced; contact our warranty administrators on 0870 010 7887 who will give you details for your local Service Force repair agent.

Permanent connection

In the case of permanent connection it is necessary that you install a double pole switch between the appliance and the electricity supply (mains), with a minimum gap of 3mm between the switch contacts and of a type suitable for the required load in compliance with the current electrical regulations.

The switch must not break the yellow and green earth cable at any point.



Any electrical and/or plumbing work required to install this appliance should be carried out by a qualified electrician and/or plumber or competent person.

Remove all packaging before positioning the machine. If possible, position the machine next to a water tap and a drain.

Water supply connections

We recommend that this dishwasher is connected to your cold water supply.

For making the connection itself, the coupling nut fitted to the machine's supply hose is designed to screw onto either a 3/4" inch gas thread spout or to a purpose made quick-coupling tap such as the Press-block.

The water pressure must be within the limits given in the "Technical specifications" shown on page 6. Your local Water Authority will advise you on the average mains pressure in your area.

The water inlet hose must not be kinked, crushed, or entangled when it is being connected up.

The dishwasher features fill and drain hoses which can be turned either to the left or the right to suit the installation by means of the locknut. **The locknut must be correctly fitted to avoid water leaks. (Important! NOT all models of dishwashers have fill and drain hoses provided with locknut. In this case, this kind of facility is not possible).**

If the machine is connected to new pipes or pipes which have not been used for a long time, you should run the water for a few minutes before connecting the inlet hose.

DO NOT use connection hoses which have previously been used for an old appliance.

This appliance has been fitted with safety features which will prevent the water used in the appliance from returning back into the drinking water system. This appliance complies with the applicable plumbing regulations.

Water inlet hose with safety valve

After connecting the double-walled water inlet hose, the safety valve is next to the tap. Therefore the water inlet hose is only under pressure while the water is running. If the water inlet hose starts to leak during this operation, the safety valve cuts off the running water.

Please take care when installing the water inlet hose:

- The electrical cable for the safety valve is in the double-walled water inlet hose. Do not immerse the water inlet hose or the safety valve in water.
- If water inlet hose or the safety valve is damaged, remove the mains plug immediately.
- A water inlet hose with safety valve must only be replaced by a specialist or by the Service Force Centre.
- Place the water inlet hose in such a way that it is never higher than the bottom edge of the safety valve.

WARNING!
Dangerous voltage

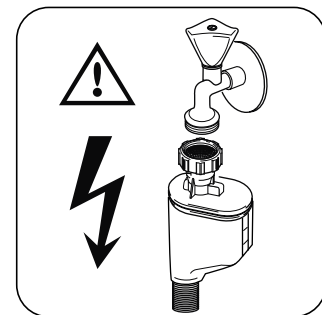

Water outlet hose connection

The end of the drain hose can be connected in the following ways:

1. To the sink outlet spigot, securing it to the underside of the work surface. This will prevent waste water from the sink running into the machine.
2. To a stand pipe provided with vent-hole, minimum internal diameter 4 cm.

The waste connection must be at a height of between 30 cm (minimum) and 100 cm (maximum) from the bottom of the dishwasher.

The drain hose can face either to the right or left of the dishwasher

Ensure the hose is not bent or squashed as this could prevent or slow down the discharge of water.

The sink plug must not be in place when the machine is draining as this could cause the water to syphon back into the machine.

If you use a drain hose extension it must be no longer than 2 metres and its internal diameter must be no smaller than the diameter of the hose provided.

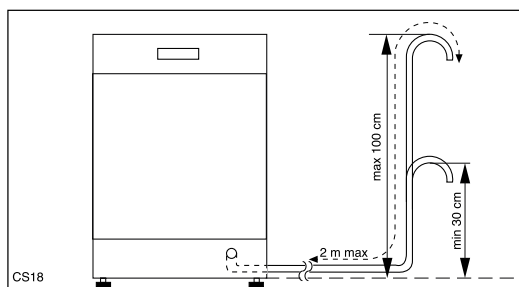

Likewise the internal diameter of the couplings used for connections to the waste outlet must be no smaller than the diameter of the hose provided.

Important!

Our appliances are supplied with a security device to protect against the return of dirty water back into the machine. If the spigot of your sink has a "no return valve" incorporated this can prevent the correct draining of your dishwasher. We therefore advise you to remove it.

Building-in

This dishwasher is designed to be fitted under a kitchen counter or work surface.

Important!

Carefully follow the instructions on the enclosed template for building in the dishwasher and fitting the furniture panel.

No further openings for the venting of the dishwasher are required, but only to let the water fill and drain hose and power supply cable pass through.

The dishwasher incorporates adjustable feet to allow the adjustment of the height.

During all operations that involve accessibility to internal components the dishwasher has to be unplugged.

When inserting the machine, ensure that the water inlet hose, the drain hose and the supply cable are not kinked or squashed.

Levelling

Good levelling is essential for correct closure and sealing of the door.

When the appliance is correctly levelled, the door will not catch on either side of the cabinet.

If the door does not close correctly, loosen or tighten the adjustable feet until the machine is perfectly level.

Fixing to the adjacent units

The dishwasher must be secured against tilting.

Therefore make sure that the counter it is fixed under, is suitably secured to a fixed structure (adjacent kitchen units cabinets, wall).

The Control Panel

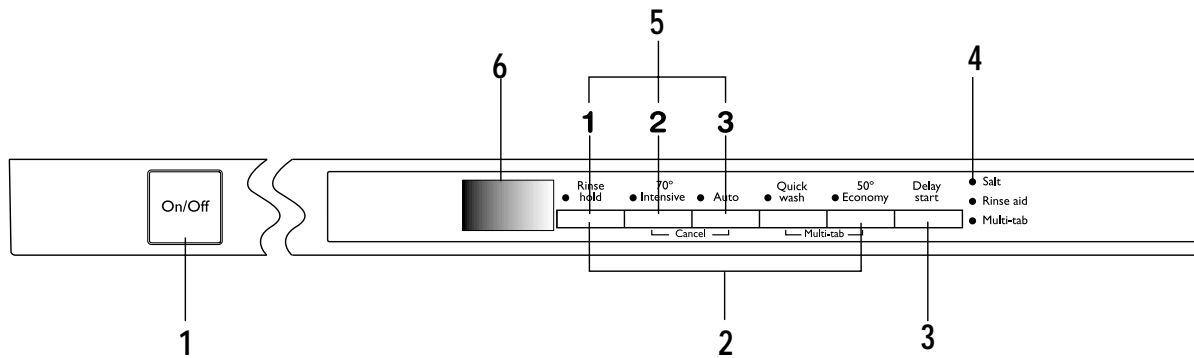

1. On/Off button

2. Programme selection buttons

The selection of a washing programme occurs by pressing one of these buttons (see "Washing programmes chart" see page 21).

3. Delay start button

This option allows the start of the programme to be delayed from 1 to 19 hours.

4. Indicator lights

Salt	salt refilling indicator light, illuminates when the salt has run out
Rinse aid	rinse aid refilling indicator light, illuminates when the rinse aid has run out
Multi-tab	Multi-tab function: indicates the activation/deactivation of the "Multi-tab" function (see "Multi-tab function")

5. Function buttons

In addition to the dishwashing programme selected, the following functions can also be set with the help of these buttons:

- the setting of the water softener,
- activation/deactivation of the rinse aid dispenser,
- the cancelling of a programme in progress,
- deactivation/activation of the audible signals.

6. The digital display indicates:

- the level of hardness to which the water softener is set,
- if the rinse aid dispenser is activated/deactivated,
- if the audible signals are activated/deactivated,
- the approximate remaining time of the running programme,
- the end of the programme (a zero will appear in the digital display),
- the countdown of the delay start,
- fault codes concerning malfunction of the dishwasher.

Multi-tab function

This appliance is equipped with the "Multi-tab" function, that allows the use of the combi detergent tablets with a combined cleaning, rinsing and salt function ("3 in 1", "4 in 1", "5 in 1" etc...).

i Before using the "Multi-tab" function, check that the water hardness level in your area complies with the detergent manufacturers recommendations.

This function can be selected with all washing programmes.

With the selection of this function the inflow of rinse aid and salt from each respective supply container is automatically deactivated and also the indicator lights for salt and rinse aid are deactivated.

Select the "**Multi-tab**" function before the set of a washing programme.

Once selected this option (indicator light illuminated) it will remain active also for the following washing programmes.

With the use of the "**Multi-tab**" function, the cycle durations may change. In this case, in the digital display, the indication of the running time of the programme is automatically updated.

NOTE: Once the programme is running, the "**Multi-tab**" function can **NO** longer be changed. If you want to exclude the "**Multi-tab**" function you have to cancel the programme setting (see chapter "Starting a washing programme" - "Cancel a washing programme in progress") and then deactivate the "**Multi-tab**" function. In this case you have to set a washing programme (and desired options) again.

NOTE: if the drying results are not satisfactory we suggest that you activate the rinse aid dispenser.

The activation/deactivation of the rinse aid dispenser can only be possible with the "Multi-tab" function active.

Activation/deactivation of the Multi-tab function

- Press simultaneously the two buttons positioned over the writing "Multi-tab", until the "**Multi-tab**" function indicator light illuminates. This means that the function is active.
- To deactivate the function press the same buttons again until the "**Multi-tab**" function indicator light turns off.

Activation/deactivation of the rinse aid dispenser

The dishwasher must be switched off

When the rinse aid dispenser has been activated, the rinse aid indicator light on the control panel is automatically activated.

1. Press the On/Off button. The indicator lights of the programme selection buttons will illuminate (setting mode). *If only one programme button indicator light is on, this means that a washing programme is set. The programme must be cancelled: press simultaneously function buttons 2 and 3 for about 2 seconds. All programme indicator lights will illuminate indicating that the set programme has been cancelled and the machine is now in setting mode.*
2. Press simultaneously function buttons 2 and 3, until the indicator lights of function buttons 1, 2 and 3 start flashing.
3. Press function button 2, the indicator lights of function buttons 1 and 3 turn off while the indicator light of function button 2 goes on flashing, the digital display indicates the current setting.

<i>0 d</i>	Rinse aid dispenser deactivated
<i>1 d</i>	Rinse aid dispenser activated

4. To change the setting, press function button 2 again, the digital display indicates the new setting.
5. To memorise the operation, switch off the dishwasher by pressing the On/Off button.

Audible signals

Audible signals have been introduced to help indicate which operations the dishwasher is performing:

- **setting of the water softener**
- **end of programme**
- **intervention of an alarm due to malfunction**

Deactivation/activation of the audible signals

The dishwasher must be switched off

Factory setting: **audible signals activated**

1. Press the On/Off button. The indicator lights of the programme selection buttons will illuminate (setting mode).
If only one programme button indicator light is on, this means that a washing programme is set. The programme must be cancelled: press simultaneously function buttons 2 and 3 for about 2 seconds. All programme indicator lights will illuminate indicating that the set programme has been cancelled and the machine is now in setting mode.
2. Press simultaneously function buttons 2 and 3, the indicator lights of function buttons 1, 2 and 3 start flashing.
3. Press function button 3, the indicator lights of function buttons 1 and 2 turn off while the indicator light of function button 3 goes on flashing, the digital display indicates the current setting.

0b	Audible signals deactivated
1b	Audible signals activated (factory set)

4. To change the current setting, press again function button 3, the digital display will indicate the new setting.
5. To memorise the operation, switch off the dishwasher by pressing the On/Off button.

When the Dishwasher is first installed

Before using your dishwasher for the first time:

1. Ensure that the electrical and water connections comply with the installation instructions
2. Remove all packaging from inside the appliance
3. Set the water softener
4. Pour 1 litre of water inside the salt container and then fill with dishwasher salt
5. Fill the rinse aid dispenser

NOTE:

If you want to use the "3 in 1" - "4 in 1" - "5 in 1" combi tablet detergents, carefully read the information given in "Different kinds of detergents".

The water softener

The dishwasher is equipped with a water softener designed to remove minerals and salts from the water supply, which would have a detrimental or adverse effect on the operation of the appliance.

The higher the content of these minerals and salts, the harder your water is.

Water hardness is measured in equivalent scales, Clarke degrees, French degrees (°TH) and mmol/l (millimol per litre - international unit for the hardness of water).

The softener should be adjusted according to the hardness of the water in your area. Your local Water Authority can advise you on the hardness of the water in your area.

The water softener must be set in both ways: manually, using the water hardness dial and electronically, using the function buttons on the control panel.

a) Setting manually

1. Open the dishwasher door.
2. Remove the lower basket from the dishwasher.
3. Turn the water hardness dial to position 1 or 2 (see table).
4. Replace the lower basket.

The dishwasher is factory set at position 2.

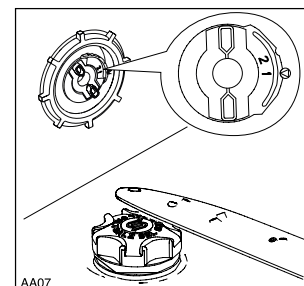

Water hardness			Adjusting the water hardness setting		Level indicated on the digital display	Number of audible signals	Use of salt
Clarke	°TH	mmol/l	manually	electronically			
64 - 88	91 - 125	9,0 - 12,5	2	level 10	10 L	10	yes
53 - 63	76 - 90	7,6 - 8,9	2	level 9	9 L	9	yes
46 - 52	65 - 75	6,5 - 7,5	2	level 8	8 L	8	yes
36 - 45	51 - 64	5,1 - 6,4	2	level 7	7 L	7	yes
28 - 35	40 - 50	4,0 - 5,0	2	level 6	6 L	6	yes
23 - 27	33 - 39	3,3 - 3,9	2	level 5	5 L	5	yes
18 - 22	26 - 32	2,6 - 3,2	1	level 4	4 L	4	yes
13 - 17	19 - 25	1,9 - 2,5	1	level 3	3 L	3	yes
5 - 12	7 - 18	0,7 - 1,8	1	level 2	2 L	2	yes
< 5	< 7	< 0,7	1	level 1	1 L	1	no

b) Setting electronically

The dishwasher must be switched off

NOTE: the electronic setting of the water softener is possible ONLY with the Multi-tab function deactivated.

The dishwasher is factory set at level 5.

1. Press the On/Off button. The indicator lights of the programme selection buttons will illuminate (setting mode).
If only one programme button indicator light is on, this means that a washing programme is set. The programme must be cancelled: press simultaneously function buttons 2 and 3 for about 2 seconds. All programme indicator lights will illuminate indicating that the set programme has been cancelled and the machine is now in setting mode.
2. Press simultaneously function buttons 2 and 3, until the indicator lights of function buttons 1, 2, and 3 start flashing.
3. Press function button 1, the indicator lights of function buttons 2 and 3 turn off while the indicator light of function button 1 goes on flashing, the digital display indicates the current level and a sequence of intermittent audible signals are heard. The current level is indicated by the number visible in the display and the number of intermittent audible signals heard.

Example:

5 L displayed + 5 audible signals = level 5.

4. To change the level, press function button 1. Each time the button is pressed the level changes. (For the selection of the new level see the chart).

Examples:

if the current level is 5, by pressing function button 1 once, level 6 is selected.

if the current level is 10, by pressing function button 1 once, level 1 is selected.

5. To memorise the operation, switch off the dishwasher by pressing the On/Off button.

Filling with dishwasher salt

Only use salt specifically designed for use in dishwashers. All other types of salt not specifically designed for use in a dishwasher, especially table salt, will damage the water softener.

Only fill with salt just before starting one of the complete washing programmes.

This will prevent any grains of salt or salty water, which may have been spilt, remaining on the bottom of the machine for any period of time, which may cause corrosion.

To fill:

1. Open the door, remove the lower basket and unscrew the cap of the salt container by turning it anticlockwise.
2. Pour 1 litre of water inside the container (**this is necessary only before filling with salt for the first time**).
3. Using the funnel provided, pour in the salt until the container is full.
4. Replace the cap making sure that there is no trace of salt on the screw thread or on the gasket.
5. Replace the cap tightly turning it clockwise until it stops with a click.

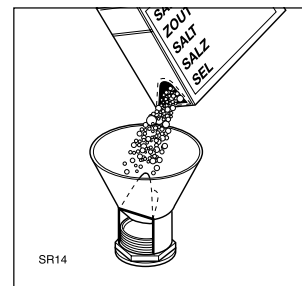

The salt container will require topping up periodically. You are reminded of this by the salt indicator light on the control panel which comes on when the salt has finished.

The salt indicator light on the control panel can remain illuminated for 2-6 hours after the salt has been replenished, assuming the dishwasher remains switched on. If you are using salts that take longer to dissolve then it will take longer. The function of the machine is not affected.

Do not worry if water over flows from the unit when filling with salt, this is quite normal.

Rinse aid

Rinse aid is automatically added during the last rinse, ensuring thorough rinsing, and spot and streak free drying.

The dispenser, which is positioned inside the door, holds about 110 ml of rinse aid, which is sufficient for 16 - 40 dishwashing programmes, depending upon the dosage setting.

Filling with rinse aid

1. Open the container by pressing the release button (A).
2. Add the rinse aid until the container is completely full. The maximum level for filling is indicated by "max".

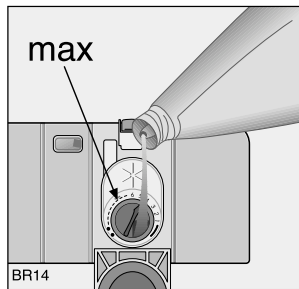
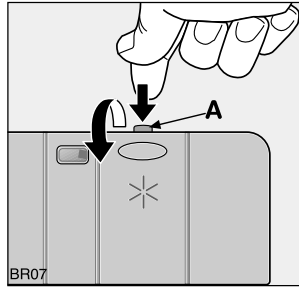

Ensure that the lid is closed after every refill.

Clean up any rinse aid spilt during filling with an absorbent cloth to avoid excess foaming during the next wash.

Only use branded rinse aid for dishwashers, available also from your local John Lewis store.

Never fill the rinse aid dispenser with any other substances (e.g. dishwasher cleaning agent, liquid detergent). This would damage the appliance.

Adjusting the dose

According to the finish and drying results obtained, adjust the dose of rinse aid by means of the 6 position selector (position 1 minimum dosage, position 6 maximum dosage).

The dose is factory set in position 4.

Increase the dose if there are drops of water or lime spots on the dishes after washing.

Reduce it if there are sticky whitish streaks on the dishes or a bluish film on glassware or knife blades.

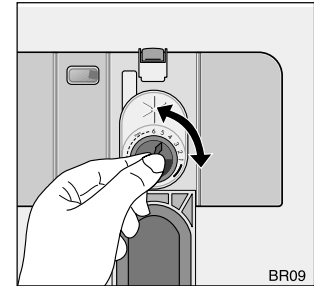

Top up the rinse aid when the indicator light on the control panel illuminates.

Using the Dishwasher

- Check if it's necessary to refill with dishwasher salt or rinse aid
- Load cutlery and dishes into the dishwasher.
- Fill with dishwasher detergent .
- Select a wash programme suitable for the cutlery and dishes.
- Start the wash programme.

Loading cutlery and dishes

Sponges, household cloths and any object that can absorb water may not be washed in the dishwasher.

- Before loading the dishes, you should:
 - Remove all left over food and debris.
 - Soften remnants of burnt food in pans
- When loading the dishes and cutlery, please note:
 - Dishes and cutlery must not impede the rotation of the spray arms .
 - Load hollow items such as cups, glasses, pans, etc. with the opening downwards so that water cannot collect in the container or a deep base.
 - Dishes and items of cutlery must not lie inside one another, or cover each other.
 - To avoid damage to glasses, they must not touch.
 - Lay small objects in the cutlery basket.
- **Plastic items and pans with teflon have a tendency to retain water drops; these items will not dry as well as porcelain and steel items.**

Beware: Some cutlery / dishes are not suitable or of limited suitability to be washed in dishwashers'

not suitable:	of limited suitability:
<ul style="list-style-type: none">- Cutlery with wooden, bone, china or mother-of-pearl handles- Plastic items that are not heat resistant- Older cutlery with glued parts that is not temperature resistant- Bonded cutlery items or dishes- Pewter or copper items- Lead crystal glass- Steel items prone to rusting- Wooden platters- Items made from synthetic fibres	<ul style="list-style-type: none">- Only wash stoneware in the dishwasher if it is specifically marked as being dishwasher-safe by the manufacturer.- Glazed patterns may fade if machine washed frequently- Silver and aluminium parts have a tendency to discolour during washing. Residues, e.g. egg white, egg yolk and mustard often cause discolouring and staining on silver. Therefore always clean left-overs from silver immediately, if it is not to be washed straight after use.- Some types of glass can become dull after a large number of washes

Open the door and slide out the baskets to load the dishes.

The lower basket

The lower basket is designed to take saucepans, lids, plates, salad bowls, cutlery etc.

Serving dishes and large lids should be arranged around the edge of the basket, ensuring that the spray arms can turn freely.

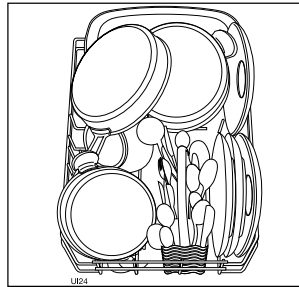
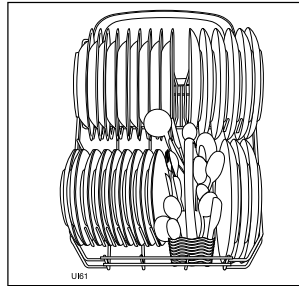

The two rows of prongs on the lower basket can be easily lowered to allow you to load pots, pans and bowls.

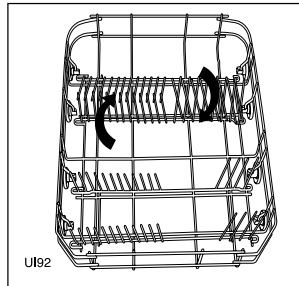

The cutlery basket



Warning!

Long bladed knives stored in an upright position are a potential hazard. Long and/or sharp items of cutlery such as carving knives must be positioned horizontally in the upper basket. Take care when loading or unloading sharp items such as knives.

Forks and spoons should be placed in the removable cutlery basket with the handles facing downwards and the knives with their handles facing upwards.

If the handles protrude from the bottom of the basket, obstructing the lower spray arm, load the cutlery with the handles facing upwards.

Mix spoons with other cutlery to prevent them from sticking together.

For best results we recommend you to use the cutlery grid provided (if the size and dimensions of the cutlery allow it).

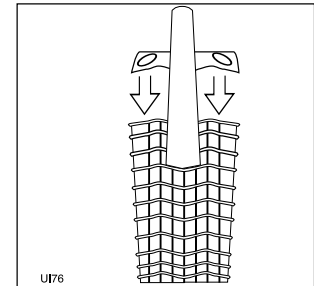

The upper basket

The upper basket is designed for plates (dessert plates, saucers, dinner plates of up to 24 cm in diameter), salad bowls, cups and glasses.

Arrange items on and underneath the cup racks so that water can reach all surfaces.

For taller items, the cup racks can be folded upwards.

Light items (plastic bowls etc.) must be loaded in the upper basket and arranged so they do not move.

For glasses with long stems (according to the size and dimensions), set the glass holder to the left-hand or right-hand position.

In case you need to load dishes in the upper basket, the glass holder must be in the right-hand position.

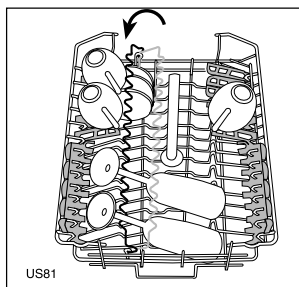
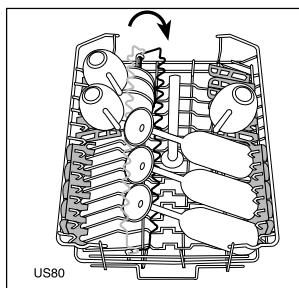
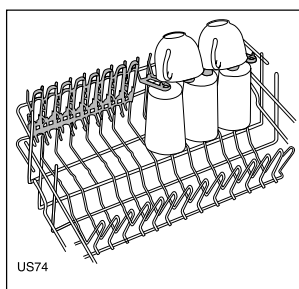
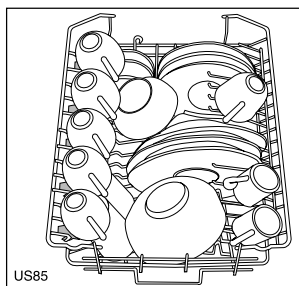

Before closing the door, ensure that the spray arms can rotate freely.

Adjusting the height of the upper basket

If washing very large plates you can load them in the lower basket after moving the upper basket to the higher position.

	Maximum height of the dishes in	
	upper basket	lower basket
With upper basket raised	20 cm	31 cm
With upper basket lowered	24 cm	27 cm

To move to the higher position proceed as follows:

1. Pull out the basket until it stops.
2. Carefully lift both sides upwards until the mechanism is engaged and the basket is stable.

Warning!

Never lift or lower the basket on one side only

When the basket is in the higher position you will not be able to use the cup rack(s).

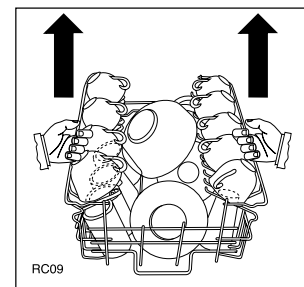

To lower the basket to the original position proceed as follows:

1. Pull out the basket until it stops.
2. Carefully lift both sides upwards and then allow the mechanism to drop back down slowly, keeping hold of it.

After loading your machine always close the door, as an open door can be a hazard.

Use of detergent

i Only use detergents specifically designed for use in dishwashers.

Please observe the manufacturer's dosing and storage recommendations as stated on the detergent packaging.



Using no more than the correct amount of detergent contributes to reducing pollution.

Fill with detergent

1. If the lid is closed: press release button (1). The lid springs open.

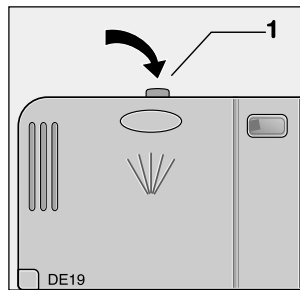

2. Fill the detergent dispenser (2) with detergent.

The marking indicates the dosing levels:

20 = approximately 20 g of detergent

30 = approximately 30 g of detergent

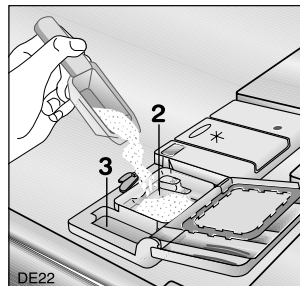

3. All programmes with prewash need an additional detergent dose (5/10 g) that must be placed in the prewash detergent chamber (3). This detergent will take effect during the prewash phase.
4. Close the lid and press until it locks in place.

Different kinds of detergent

Concentrated detergent

Modern detergents for dishwashers are almost exclusively low-alkaline concentrated detergents with natural enzymes in tablet form.

Using 50°C washing programmes in conjunction with these concentrated detergents reduces pollution and is good for your dishes, as these washing programmes are specially matched to the dirt-dissolving properties of the enzymes in concentrated detergents. It is for this reason that using 50°C washing programmes in conjunction with concentrated detergents can achieve the same cleaning results that can otherwise only be achieved using 65°C washing programmes.

Detergent tablets

Detergent tablets from different manufactures dissolve at different rates. For this reason, some detergent tablets do not attain their full cleaning power during short washing programmes. Therefore please use long washing programmes when using detergent tablets, to ensure the complete removal of detergent residuals.

Use of combi tablet detergents

This appliance is equipped with the "Multi-tab" function, that allows the use of combi tablet detergent.

These products are detergents with a combined cleaning, rinsing and salt functions. They can also contain other different agents depending on which kind of tablets you choose ("3 in 1", "4 in 1", "5 in 1" etc...)

1. Check whether these detergents are suitable for your water hardness. Follow the manufacturers instructions.
2. Set the "Multi-tab" function.
3. Before the start of the washing programme put the tablet detergent in the detergent dispenser.

NOTE: If the drying results are not satisfactory we recommend that you:

1. Fill up the rinse aid dispenser with rinse aid.
2. Activate the rinse aid dispenser and set the rinse aid dosage to position 2.

If you decide to turn back to the use of the standard detergent system we advise that you:

- Deactivate the "Multi-tab" function.
- Fill up the dispensers for salt and rinse aid again.
- Adjust the water hardness setting to the highest setting perform up to 3 normal washing programmes without loading any dishes.
- Adjust the water hardness setting according to the hardness of the water in your area.
- Adjust the rinse aid dosage.

Washing Programmes

Programme	Degree of soil and type of load	Press the programme button	Cycle description	(3) Consumption values	
				Energy consumption (in kWh)	Water consumption (in litres)
Rinse and hold	Any. Partial load (to be completed later in the day or when the dishwasher is full).	Rinse hold	1 cold rinse (to avoid food scraps from sticking together). This programme does not require the use of detergent.	0,1	3 - 4
Intensive 70°C	Heavy soil. Crockery, cutlery, pots and pans	70° Intensive	Hot prewash Main wash up to 70°C 2 warm rinses 1 hot rinse Drying	1,6 - 1,8	19 - 21
(1) Automatic	Normal soil. Crockery and cutlery	Auto	Cold prewash Main wash up to 65°C or 50°C 1 or 2 cold rinses 1 hot rinse Drying	0,8 - 1,2	12 - 21
Quick wash	Light soil. Crockery and cutlery	Quick wash	Main wash up to 60°C 1 hot rinse	0,7 - 0,8	7 - 8
(2) Economy 50°C	Normal soil. Crockery and cutlery	50° Economy	Cold prewash Main wash up to 50°C 1 cold rinse 1 hot rinse Drying	0,8	14

(1) "Automatic" washing programme

During the "Automatic" washing programme the amount of soil on the dishes is determined by how cloudy the water is. If the appliance is partially loaded and the dishes lightly soiled, the "prewash", "main wash", and "rinse" phases of the programme are shorter and the water consumption level is lower.

If the appliance is fully loaded and the dishes heavily soiled, the "prewash", "main wash", and "rinse" phases of the programme are longer and the water consumption level is higher.

During the "Automatic" programme the temperature of the main wash water is also automatically adjusted between 50°C and 65°C depending on the amount of soil on the dishes.

(2) Testing programme for EN 50242 (see "Hints for Test Centres"). This programme, developed for the use of detergents with enzymes, allows you to achieve, with reduced consumption of energy the same cleaning results that would otherwise be obtained only with the 65°C programmes and conventional detergents. To compensate the lower temperature, the duration of washing and drying have been extended.

(3) The consumption values are intended as a guide and depends on the pressure and the temperature of the water and also by the variations of the power supply. The programme duration is visible in the display when the setting of the programme occurs.

Starting a Washing Programme

In this fully integrated appliance the controls are located on the top of the door. When selecting a programme, the door needs to be open.

1. **Check that the baskets have been loaded correctly and that the spray arms can rotate freely**

2. **Turn on the water tap**

3. **Press the On/Off button**

The indicator lights of the programme selection buttons illuminate.

4. **Setting and starting the programme**

To select a programme, press the button of the programme you wish to select, (see "Washing programmes" chart), the indicator light of the selected programme button remains illuminated while the other programme indicator lights turn off. In the digital display will appear, flashing, the running time of the programme that has been set (in minutes).

Close the dishwasher's door, the programme will start automatically.

Setting and starting the programme with the delay start

Once the washing programme has been selected press the **delay start** button until the flashing number of the hours for the delay start will appear in the digital display (from 1h to 19h).

Close the dishwasher door, the countdown starts automatically and will decrease with steps of 1 hour.

The opening of the door during the countdown will not modify the delay start.

Once the delay start has elapsed the programme will start automatically.

i **Note:** The start of the programme or the countdown of the delay start will only commence after the closure of the door.

Until that moment it is possible to modify the settings made.



Note: Once the washing programme has started, a point-shaped optical signal appears on the floor beneath the dishwasher's door. This optical signal will remain illuminated for all the duration of the washing programme.

If the appliance has been installed higher up with a furniture door mounted flush, the optical signal will be no longer visible.

5. **To interrupt or cancel a washing programme in progress**

Interrupt or cancel a washing programme in progress ONLY if it's absolutely necessary.



Attention! Hot steam may escape when the door is opened. **Open the door carefully.**

Interrupt a washing programme in progress

Open the dishwasher door; the programme will stop. Close the door; the programme will start from the point at which it was interrupted.

Cancel a washing programme in progress

Open the dishwasher door.

Press simultaneously function buttons **2** and **3** for about 2 seconds. After about 2 seconds all the programme indicator lights will illuminate indicating that the running programme has been cancelled.

If a new washing programme is to be selected, check that there is detergent in the detergent dispenser.

6. **To cancel a delay start**

To cancel a delay start in progress you have to reset the dishwasher; follow the same instructions given in "Cancel a washing programme in progress". Cancelling a delay start involves also the cancelling of the washing programme set.

In this case you have to set the washing programme again.

7. End of the washing programme

The dishwasher will automatically stop and an audible signal informs you of the end of the washing programme.

When the washing programme has ended, the optical signal on the floor beneath the dishwasher's door will turn off. Open the dishwasher door only when this optical signal turns off.

i The dishwasher's drying system is provided with a device that allows air to circulate inside the dishwasher to prevent residual steam recondensing on the dishes as water droplets.

Once the washing programme has ended this device operates intermittently for other 20 minutes, as long as the dishwasher is switched on.

If the On/Off button is pressed or the door is opened during these 20 minutes, the device will be automatically cancelled.

Open the dishwasher's door, leave it ajar and wait a few minutes before removing the dishes; in this way they will be cooler and the drying will be improved.

In the digital display appears 0, only in this case the programme has ended.

Switch off the dishwasher by pressing the On/Off button.

8. Unloading the dishwasher

Hot dishes are sensitive to knocks. The dishes should therefore be allowed to cool down before removing from the appliance.

Empty the lower basket first and then the upper one; this will avoid water dripping from the upper basket onto the dishes in the lower one.

Water may appear on the sides and the door of the dishwasher as the stainless steel will eventually become cooler than the dishes.

i **When the washing programme has finished, it is recommended that the dishwasher is unplugged and the water tap turned off.**

Maintenance and Cleaning

You must disconnect the appliance from the electricity supply, before you can carry out any cleaning and maintenance work.

External cleaning

Clean the external surfaces of the machine and control panel with a damp soft cloth. If necessary use only neutral detergents. Never use abrasive products, scouring pads or solvent (acetone, trichloroethylene etc....).

Ensure that the seals around the door, the detergent and rinse aid dispensers are cleaned regularly with a damp cloth.

We recommend every 3 months to run a 65°C wash programme without dishes using detergent.

Cleaning the filters

The filters must be checked and cleaned from time to time. Dirty filters will degrade the washing result.

1. Open the door, remove the lower basket.
2. The dishwasher filter system comprises a coarse filter (A), a microfilter (B) and a flat filter (C).
Unlock the filter system using the handle on the microfilter, and remove.

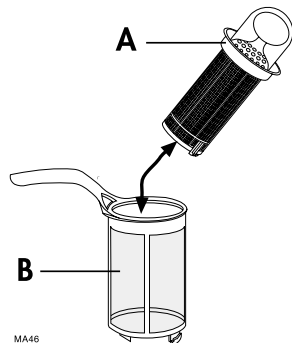

3. Turn the handle about 1/4 a turn anticlockwise and remove.

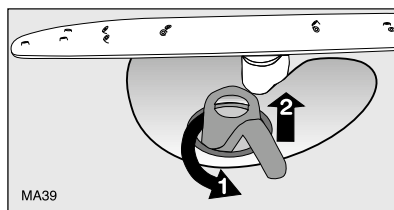

4. Take hold of the coarse filter (A) by the handle with the hole and remove from the microfilter (B).
5. Clean all filters thoroughly under running water.
6. Remove the flat filter (C) from the base of the washing compartment and clean both faces thoroughly.

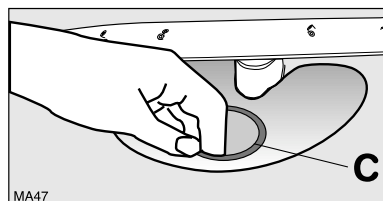

7. Put the flat filter (C) back in the base of the washing compartment.
8. Place the coarse filter (A) in the microfilter (B) and press together.
9. Put the filter combination in place and lock by turning the handle clockwise to the stop. During this process ensure that the flat filter does not protrude above the base of the washing compartment.

i **Warning!**
Under no circumstances may the dishwasher be used without filters. Incorrect repositioning and fitting of the filters will produce poor washing results.

NEVER try to remove the upper spray arm.

If residues of soil have clogged the holes in the upper spray arm, remove them with a cocktail stick.

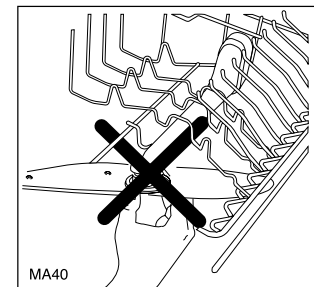

Prolonged periods of non-operation

If you are not using the machine for any period of time you are advised to:

1. Unplug the appliance and then turn off the water.
2. Leave the door ajar to prevent the formation of any unpleasant smells.
3. Leave the inside of the machine clean.

Frost precautions

Avoid placing the machine in a location where the temperature is below 0°C. If this is unavoidable, empty the machine, close the appliance door, disconnect the water inlet pipe and empty it.

Moving the machine

If you have to move the machine (moving house etc...):

1. Unplug it.
 2. Turn the water tap off.
 3. Remove the water inlet and discharge hoses.
 4. Pull the machine out together with the hoses.
- Avoid over tilting the machine during transportation.

Something Not Working

If the dishwasher is not working correctly, please carry out the following checks, before contacting your local Service Force agent.

Important! If you call out an engineer to a fault listed below, or to repair a fault caused by incorrect use or installation, a charge will be made even if the appliance is under guarantee.

...a flashing fault code appears

The dishwasher will not start or stops during operation and a sequence of intermittent audible signals are heard.

The point-shaped optical signal on the floor beneath the dishwasher's door is flashing (not visible if the appliance has been installed higher up with a furniture door mounted flush).

Open the dishwasher's door.

The intervention of an alarm is indicated by:

- the continuous flashing of the indicator light of the running programme,
- a fault code (as described in the chart) is visible in the digital display.

Carry out the following suggested corrective actions.

Symptom	Possible cause	Solutions
<p>- .10 in the digital display appears</p> <p>The machine does not fill with water.</p>	The water tap is blocked or furred with limescale.	Clean the water tap.
	The water tap is turned off.	Turn the water tap on.
	The filter (where present) in the threaded hose fitting at the water inlet valve is blocked.	Clean the filter in the threaded hose fitting.
	The water inlet hose has not been correctly laid or it is bent or squashed.	Check the water inlet hose connection.
<p>- .20 in the digital display appears</p> <p>The dishwasher will not drain.</p>	The sink spigot is blocked.	Clean out the sink spigot.
	The water drain hose has not been correctly laid or it is bent or squashed.	Check the water drain hose connection.
<p>- .30 in the digital display appears</p>	Anti-flood device has activated.	Close the water tap and contact our extended warranty administrators, refer to Repairs - After Sales Service on page 26.

Once the checks have been carried out, to continue de programme, press the button of the programme that was running before the intervention of the alarm and close the door. The programme will continue from the point at which it was interrupted.

If the fault code reappears or if another fault code not described above appears contact our extended warranty administrators, refer to Repairs - After Sales Service on page 26.



Attention: once having verified which kind of malfunction has occurred, before carrying out the checks the appliance **MUST** be switched off.

...there are problems when operating the dishwasher

Symptom	Possible cause	Solutions
The programme does not start	The dishwasher door has not been properly closed.	Close the door.
	The main plug is not plugged in.	Insert the mains plug.
	The fuse has blown in the household fuse box.	Replace the fuse.
	Delay start has been selected.	If dishes are to be washed immediately, cancel the delay start.
There is a whistling noise during washing	The whistling is not a cause for concern.	Use a different brand of detergent.

...the wash results are not satisfactory

The dishes are not clean

- The wrong washing programme has been selected.
- The dishes were arranged in such a way as to stop water reaching all parts of the surface. The baskets must not be overloaded.
- The spray arms do not rotate freely due to wrong arrangement of the load.
- The filters in the base of the washing compartment are dirty or incorrectly positioned.
- Too little or no detergent has been used.
- Where there are limescale deposits on the dishes; the salt container is empty or the wrong level of the water softener has been selected.
- The drain hose connection is not correct.
- The salt container cap is not properly closed.

The dishes are wet and dull

- Rinse aid was not used.
- The rinse aid dispenser is empty.

There are streaks, milky spots or a bluish coating on glasses and dishes

- Decrease rinse aid dosing.

Water drops have dried onto glasses and dishes

- Increase rinse aid dosing.
- The detergent may be the cause. Contact the detergent manufacturer's consumer care line.

Repairs - After Sales Service

If the unlikely event of your appliance requiring service, or if you wish to purchase spare parts, please contact our extended warranty administrators by telephoning:

0870 010 7887

They will give you details of your local Service Force Centre. Before calling out an engineer, please ensure you have read the details under the heading "Something Not Working". When you contact your local Service Force Centre you will need to give the following details:

1. Your name, address and post code
2. Your telephone number
3. Clear and concise details of fault
4. The purchase date (found on your receipt)
5. The model and serial number of the appliance (found on the rating plate - see picture)

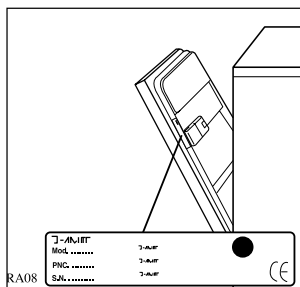

So that you always have these numbers at hand, we recommend that you make a note of them here:

Mod. :

PNC :

S.N.:

Your dishwasher is covered by a 3 year parts and labour guarantee (see separate details given at point of sale). Please retain your purchase receipt safely for the service engineer to verify the purchase details.

Spare Parts

Always insist on genuine spare parts. An authorised service engineer should service this product and only genuine spare parts should be used. Under no circumstances should you attempt to repair the machine yourself. Repairs carried out by inexperienced persons may cause injury or serious malfunctioning. Contact your local Service Force Centre by telephoning:

0870 010 7887

An authorised service engineer always insist on genuine spare parts.

