

JLBIWD 1400

Built-in 1400 spin washer-dryer

Instruction manual

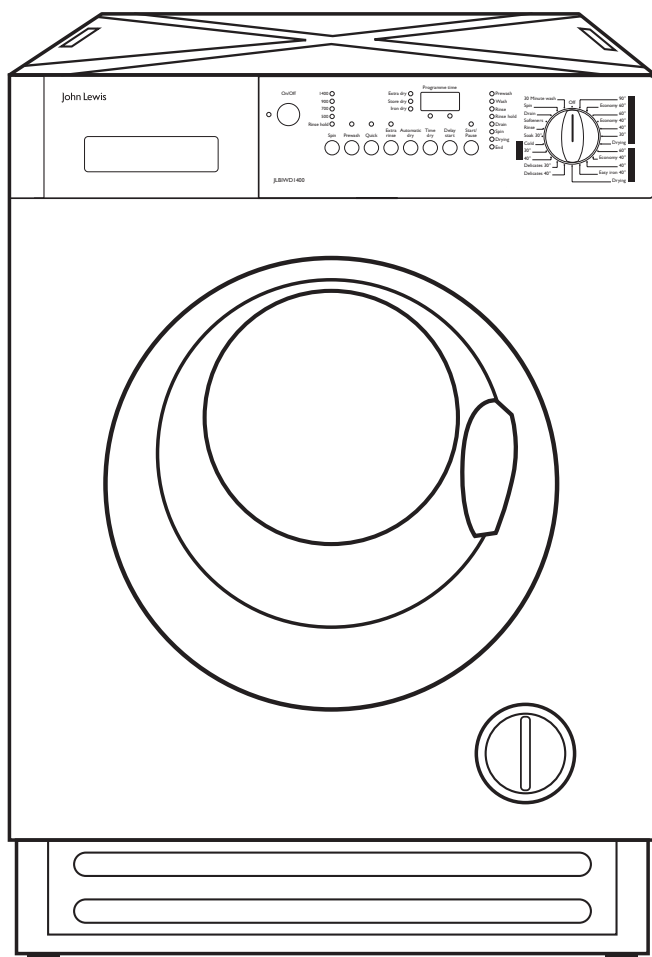

John Lewis



Important Safety Information

It is most important that this instruction book should be retained with the appliance for future reference. Should the appliance be sold or transferred to another owner, or should you move house and leave the appliance, always ensure that the book is supplied with the appliance in order that the new owner can get to know the functioning of the appliance and the relevant warnings. These warnings have been provided in the interest of safety. You **MUST** read them carefully before use or installation by a qualified person. If you are unsure of the meanings of these warnings contact the John Lewis branch from which you purchased the appliance.

Installation

- This appliance is heavy. Care should be taken when moving it.
- It is dangerous to alter the specifications or attempt to modify this product in any way.
- All packing and transit bolts must be removed before use. Serious damage can occur to the product and to property if this is not adhered to. See relevant section in instructions.
- Care must be taken to ensure that the appliance does not stand on the electrical supply cable.
- If the machine is situated on a carpeted floor, please adjust the feet in order to allow air to circulate freely.

Child Safety

- This appliance is designed to be operated by adults. Children should not be allowed to tamper with the controls or play with the product.
- Pets and children have been known to climb into washer-dryers. Please check your drum before use.
- The glass door becomes very hot during the washing cycle. Keep children away from the vicinity of the appliance whilst it is in operation.
- Keep all packaging well away from children.
- Keep all detergents in a safe place out of children's reach.

Use

- Always unplug the appliance and turn off the water supply after use.
- Do not overload the appliance. See relevant section in the instruction book.
- Only wash and dry fabrics which are designed to be machine washed and dried. If in doubt, consult the care label on the clothes.
- Before washing, ensure that all pockets are empty and buttons and zips are fastened. Avoid washing frayed or torn articles and treat stains such as paint, ink, rust, and grass before washing. Underwired bras must **NOT** be machine washed.

- Any objects such as coins, safety pins, nails, screws, stones or any other hard, sharp material can cause extensive damage and must not be placed into the machine.
- Garments which have been in contact with volatile petroleum products should not be machine washed. If volatile cleaning fluids are used, care should be taken to ensure that the fluid is removed from the garment before placing in the machine.
- Wash small items such as socks, laces, washable belts etc in a washing bag or pillow case as it is possible for such items to slip down between the tub and the inner drum.
- Only use the advised quantities of fabric softener. Damage to the fabric can ensue if you over-fill. Refer to the manufacturer's recommendations of quantities.
- As some duvets and eiderdowns should be washed/dried in large commercial machines because of their bulk, please check with the manufacturer of the item before washing in a domestic machine.
- The users should always check that they have not left their gas lighters (disposable or otherwise) in their clothing.
- Never tumble dry items that have had contact with chemicals such as dry cleaning fluid. These are of a volatile nature and could cause an explosion. Only tumble dry items which have been washed in water or require airing.

Maintenance and Cleaning

- Plastic detergent dispensers should not remain in the drum during the drying cycle, as the plastic used is not designed to withstand the heat. If you wish to wash-through-to-dry you should use the conventional detergent dispenser drawer.
- Leave the porthole door slightly ajar between washes to preserve the door seal.

Service

- Under no circumstances should you attempt to repair the machine yourself. Repairs carried out by inexperienced persons may cause injury or serious malfunctioning. Contact your local Service Force Centre. Always insist on genuine spare parts.

Contents

Important Safety Information	2	Select the desired programme/temperature	20
Your New Washer-Dryer	4	Select the spin speed or the “Rinse hold” option	20
Description of the Appliance	5	Select the desired options	20
Detergent dispenser drawer	5	Select the “Delay start”	20
Child safety feature	5	Start the programme	20
For the Installer		How to change an option or a programme during its cycle	20
Installation Instructions	6	How to interrupt a programme	21
Technical Specifications	6	How to open the door during the cycle of a programme	21
Unpacking	7	End of programme	21
Positioning	7	Drying 2.5 kg of cotton	22
Installation on a suspended floor	7	Autodrying 1.5 kg of synthetics	22-23
Building-in	8-10	Washing and Drying	24
Water inlet	10	Wash Care Symbols	24
Water drainage	11	Washing Programmes	26-27
Levelling	12	Drying Programmes	28
Special conditions	12	Maintenance and Cleaning	29-30
In the interest of the environment	12	Descaling	29
Electrical connection	12-13	After each wash	29
Permanent connection	13	Maintenance Wash	29
For the User		External cleaning	29
The Control Panel	14-17	Cleaning the dispenser drawer	29
Programme information	18	Cleaning the drawer recess	29
Operating Sequence	19-21	Cleaning the filter	29-30
Load the laundry	19	Cleaning the water inlet filter	30
Measure out the detergent	19	The dangers of freezing	30
Measure out the fabric softener	19	Emergency emptying out	30
Switch the machine on	19	Something Not Working	31-32
		Service and Spare Parts	33



This appliance complies with the following E.E.C. Directives:
 - 73/23 EEC of 19.2.73 (Low Voltage Directive) and subsequent modifications;
 - 89/336 EEC of 3.5.89 (Electromagnetic Compatibility Directive) and subsequent modifications.

Guide to use the Instruction Book

The following symbols will be found in the text to guide you throughout the instructions:



Safety instructions



Hints and tips



Environmental information

Your New Washer-Dryer

Your new washer-dryer, which is fitted with the Jet System, meets all modern requirements for effective treatment of laundry with low water, energy and detergent consumption.

Even small loads are washed “economically” because the amount of water used is regulated automatically according to the load and type of fabric.

- **The programme progress display** shows the programme steps selected, the programme phase which is running and the end of the programme.
- **The programme selector dial** combines the function of programme and temperature selection, making it easier to set the programme.
- **Automatic cooling of the wash water to 60°C** before draining, with the 90°C programme. This reduces thermal shock to fabrics, helping to prevent creasing.
- **The special wool programme** with its new delicate wash system treats your woollens with extreme care.
- **The balance control device** ensures that the washer-dryer remains stable when spinning.
- **The two drying programmes** will give your wash that soft, relaxed feel whatever the weather.

Ecological hints

To save water and energy and help protect the environment, we recommend that you follow these hints:

- Normally soiled laundry may be washed without prewashing in order to save detergent, water and time (the environment is protected too!).
- The machine works more economically if it is fully loaded.
- With adequate pre-treatment, stains and limited soiling can be removed; the laundry can then be washed at a lower temperature.
- Measure out detergent according to the water hardness, the degree of soiling and the quantity of laundry being washed.
- Try to load the maximum drying capacity of the machine as small loads are **uneconomical**.
- Save energy and reduce drying time by ensuring the laundry load has been thoroughly spun before attempting to machine dry.

Environmental Information

- Materials marked with the symbol  are recyclable.
- Check with your local Council or Environmental Health Office to see if there are facilities in your area for re-cycling this appliance.
- When the appliance is to be scrapped, cut off the power supply cable and make the door lock device unusable to prevent young children from being trapped inside.
- Help to keep your country tidy - use authorised disposal sites for your old appliance.

The symbol  on the product or on its packaging indicates that this product may not be treated as household waste. Instead it shall be handed over to the applicable collection point for the recycling of electrical and electronic equipment. By ensuring this product is disposed of correctly, you will help prevent potential negative consequences for the environment and human health, which could otherwise be caused by inappropriate waste handling of this product. For more detailed information about recycling of this product, please contact your local city office, your household waste disposal service or the shop where you purchased the product.

Important

Your machine is fitted with a balance control device, which ensures the machine is stable during the spin.



If the wash load appears not to have been spun sufficiently at the end of the wash cycle, because it is not evenly distributed in the drum, the balance control device may have operated. It will therefore be necessary to redistribute the wash load manually and select a spin programme. For more detailed information see the section headed “Something Not Working” (See pages 31 to 32).

Description of the Appliance

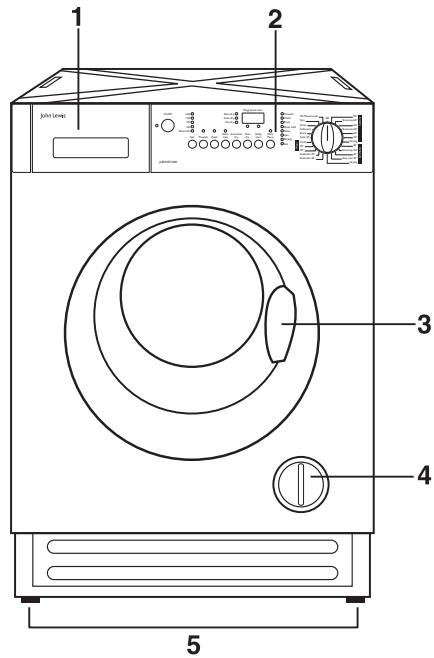
- 1 Detergent dispenser drawer
- 2 Control panel
- 3 Door opening handle
- 4 Filter
- 5 Adjustable feet



Detergent dispenser drawer

-  Prewash
-  Main wash
-  Fabric softener

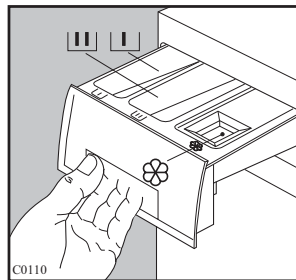

Child safety feature



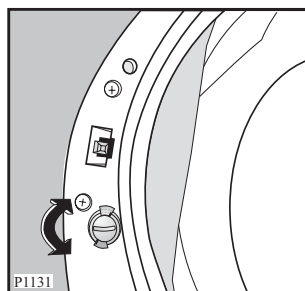

This machine incorporates a special child safety feature to prevent small children from being trapped inside the machine.

To activate this device, rotate the button (without pressing it) inside the door clockwise until the groove is horizontal. If necessary use a coin.

To disable this device and restore the possibility of closing the door, rotate the button anti-clockwise until the groove is vertical.



Installation Instructions

-  It is dangerous to alter the specifications or attempt to modify this product in any way.
-  Care must be taken to ensure that the appliance does not stand on the electrical supply cable.
-  Any electrical work required to install this appliance should be carried out by a qualified electrician or competent person.
-  Any plumbing work required to install this appliance should be carried out by a qualified plumber or competent person.

Technical Specifications

DIMENSIONS	Height Width Depth	82 cm 60 cm 54 cm
POWER SUPPLY VOLTAGE TOTAL POWER ABSORBED		230-240 V/50 Hz 2050 W (10 A)
WATER PRESSURE	Minimum Maximum	0.05 MPa (0.5 bar) 0.8 MPa (8 bar)
MAXIMUM RECOMMENDED LOAD	Washing Cotton, linen Synthetics Delicate fabrics Wool/Hand wash Drying Cotton, linen Synthetics	5 kg 2 kg 2 kg 1 kg 2.5 kg 1.5 kg
SPIN SPEED	Maximum	1400 rpm
CONSUMPTION DATA FOR WASHING 5 KG NORMALLY SOILED COTTON ITEMS WITH PROGRAMME ” “ Cottons Economy 60° ” (White Cottons):	Energy Water	0.85 kWh 49 litres

Unpacking

 All transit bolts and packing must be removed before using the appliance.

You are advised to keep all the packaging for re-use in case the machine is to be transported again.

Using a spanner unscrew and remove the rear right bolt.

Lay the machine gently on its back, making sure that the hoses are not squashed.

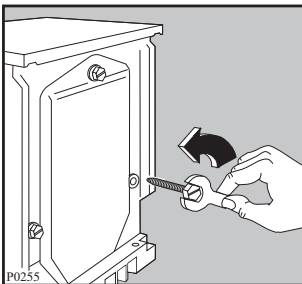

Remove the polystyrene base and take off the bottom panel by unscrewing the central screw. Carefully slide out the right polythene bag.

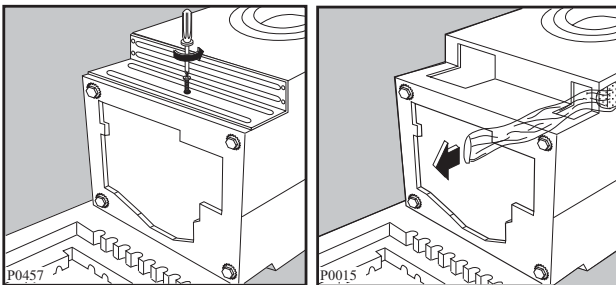

Repeat the operation for the left and central polythene bags.

Re-fit the bottom panel using the 4 screws supplied with the door hinges (in the plastic bag) and the previously removed screw.

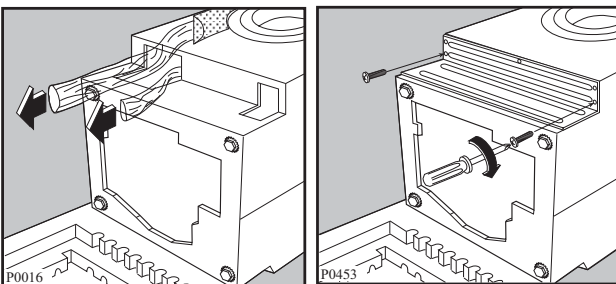

Set the machine upright and remove the two remaining bolts from the back.

Pull out the three plastic spacers from the holes into which the bolts were fitted.

Plug the open holes with the plugs supplied with the instruction booklet.

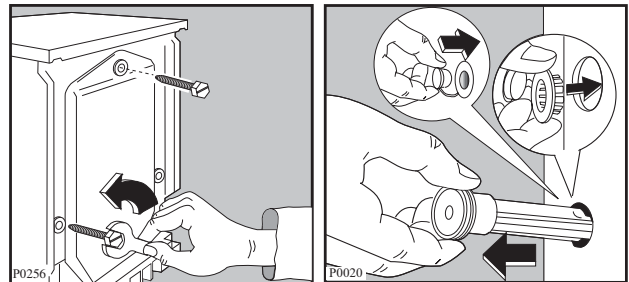

Positioning

Install the machine on a flat hard floor.

Make sure that air circulation around the machine is not impeded by carpets, rugs etc. Check that the machine does not touch the wall or other kitchen units.

Never place cardboard, wood or similar materials under the machine to compensate for any unevenness in the floor.

Your new washer-dryer has been designed to be permanently plumbed in to your home's water supply and drainage system. However, if this is not possible, it may be connected to a suitable existing tap with the drain hose discharging into a sink.

The appliance has an inlet hose, with female 3/4" BSP thread connector. If this connection is not compatible with the plumbing of the existing installation, a variety of connectors are available from good hardware stores and plumbers merchants to suit most domestic plumbing. Any alteration to your existing plumbing must be carried out by a competent person, or qualified plumber.

Installation on a Suspended Floor

Suspended wooden floors are particularly susceptible to vibration. To help prevent vibration we recommend you place a waterproof wood panel, at least 15 mm thick under the appliance, secured to at least 2 floor beams with screws. If possible install the appliance in one of the corners of the room, where the floor is more stable.

Building-in

This appliance has been designed to be built into the kitchen furniture. The recess should have the dimensions shown in picture A.

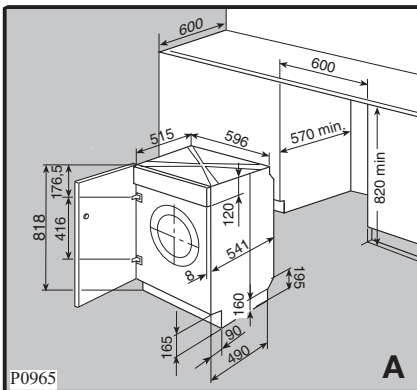

When installing the appliance into the kitchen furniture ensure, if possible, the hoses are placed in either of the two recesses on the back of the appliance. This will help to prevent the hoses from becoming kinked or trapped. Fig. AB.

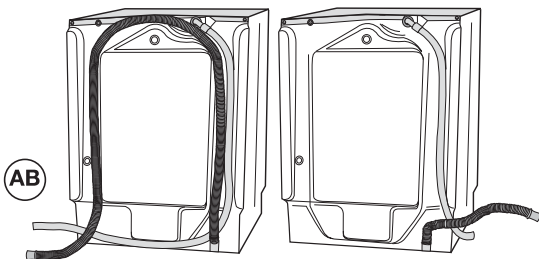

Preparation and assembly of the door

The machine is originally pre-arranged for the assembly of a door opening from right to left. In this case it is sufficient to screw in the hinges (1) and the counter-magnet (6) provided with the appliance, at the right level (Fig. B).

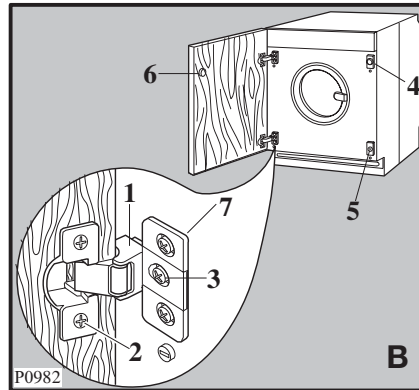

a) Door

The dimensions of the door should be:

- width 595-598 mm
- thickness 16-22 mm

The height (C-Fig. C) depends on the height of the adjacent furniture's base.

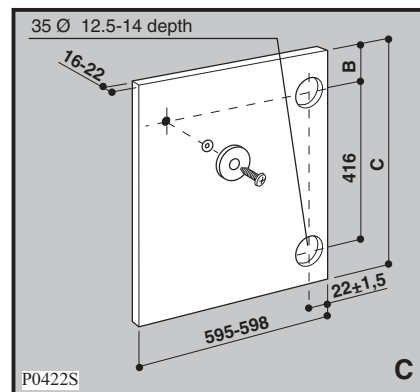

b) Hinges

To mount the hinges it is necessary to drill two holes (dia. 35 mm, depth 12.5-14 mm depending on the depth of door furniture) on the inner side of the door. The distance between the holes hobs fixing centres must be 416 mm.

The distance (B) from upper edge of the door to the centre of the hole depends on the adjacent furniture's dimensions.

The required dimensions are given in the picture C. The hinges will be fixed to the door by means of screws for wood (2-Fig. B) supplied with the appliance.

c) Mounting the door

Fix the hinges (1) to the machine by means of the M5x15 screws (3-Fig. B). The hinges can be adjusted to compensate for possible uneven thickness of the door. To align the door perfectly it is necessary to loosen the screw (3-Fig. B), adjust the door and tighten the screw again.

d) Counter-magnet (6)

The appliance is pre-arranged for a magnetic closure of the door. To enable a correct operation of this device, it is necessary to screw the counter-magnet (6) (steel disk + rubber ring) into the inner side of the door. Its position must correspond to the magnet (4) on the appliance (See fig. D).

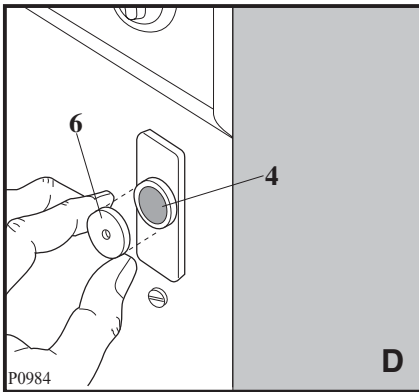

If the door has to be opened from left to right, invert the position of the plates (7), the magnet (4) and the plate (5) (Fig. B and E). Mount the counter magnet (6) and the hinges (1) as previously described.

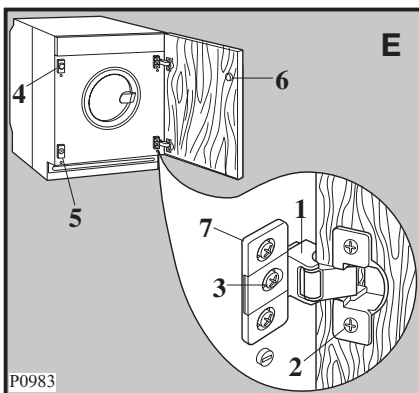

Recommendations regarding the construction and fitting of a base when the installation requires an integrated appliance to be raised

Where the appliance has been raised by mounting onto a wooden base provided by the installer. The material used to construct the base should have a non slip surface, be water repellent and if possible be one solid piece.

If it is not possible to use one solid piece, due to the additional height required, ensure that any additional strips of timber are glued and screwed to the underside of the base (see Fig. F).

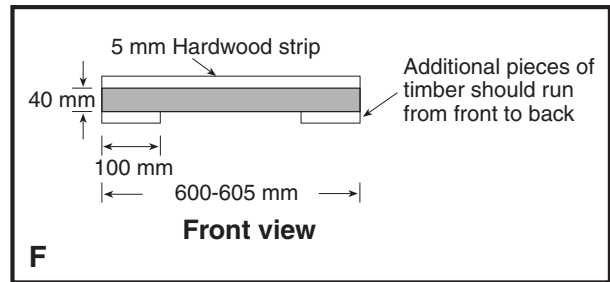

Drill four fixing holes see Fig. G

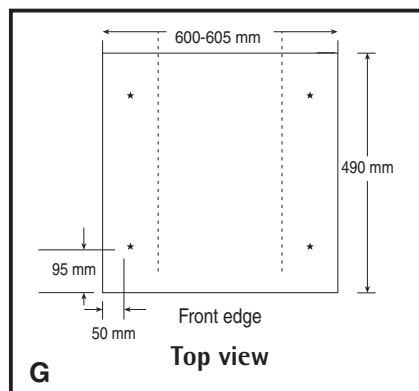

Position the base into the recess with its front edge as far forward as the adjoining plinth line will allow.

The reason for placing the base in this position is to allow a small strip of beading to be fitted in front of the appliance feet.

Fix the base firmly to the floor using four appropriate countersunk screws (see Fig. H).

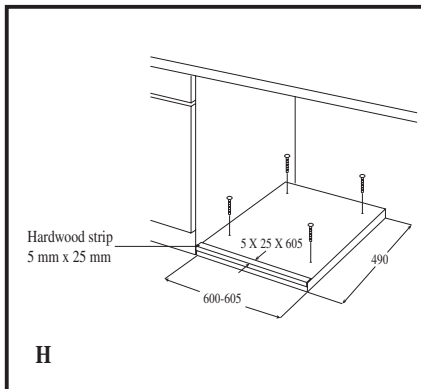

With the appliance installed adjust all four feet ensuring the machine is stable, and a clearance of approximately 5 mm is left between the top of the machine and the underside of the worktop.

A final check for stability should be carried out with the machine on spin with a load, this will identify the need for any further fine adjustment to the feet.

A strip of beading approximately 605 mm W, x 5 mm H, x 25 mm D must be screwed down into the base directly in front of the machine's feet, this will provide additional security.

If required an additional door magnet, part number 1242394-00/3 and disc, part number 1242393-00/5 are available from spare parts.

Water inlet

Connect the hose to a tap with a 3/4" thread. Always use the hose supplied with the appliance to connect to the water supply. Do not use previously used hoses for water connection.

The inlet hose is provided with a water stop device, which protects against damage caused by water leaks in the hose which could develop due to natural ageing of the hose. This fault is shown by a red sector in the window "A". Should this occur, turn the water tap off and refer to your Service Centre to replace the hose.

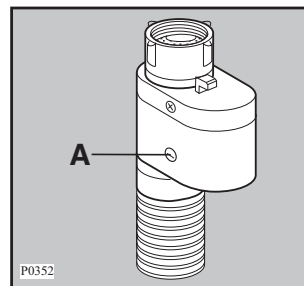

Installation should comply with local water authority and building regulations' requirements.

The appliance must be connected to a cold water supply.

A minimum water pressure of 0.05 MPa (0.5 bar) is required for safe operation of the appliance.

If you cannot make the cold water connection direct from the rising mains, you may be able to operate the appliance from your cold water storage system.

There should be a minimum distance of 5.02m (16.5 ft) between the appliance's inlet and the bottom of the water storage tank.

Set the hose correctly by loosening the ring nut. After positioning the inlet hose, be sure to tighten the ring nut again to prevent leaks.

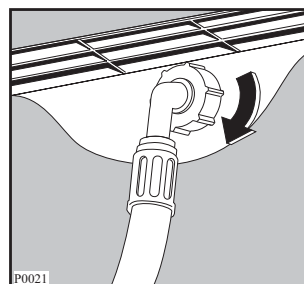

Water drainage

This appliance is designed to be permanently plumbed into your home's drainage system using one of the following methods.

1. Into a drainage standpipe.

Firstly form a hook in the end of the drain hose using the "U" piece supplied.



Place the drain hose into your standpipe, which should have an internal diameter of approximately 38mm thus ensuring there is an air break between the drain hose and standpipe.

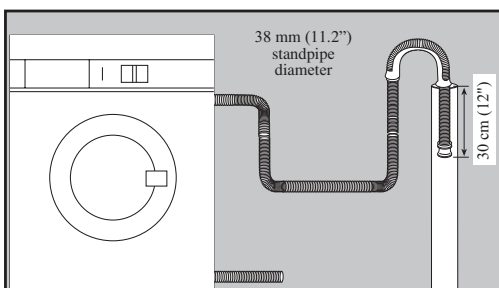

When discharging into a standpipe ensure that the top of the standpipe is no more than 90cm (35.4") and no less than 60cm (23.6") above floor level.

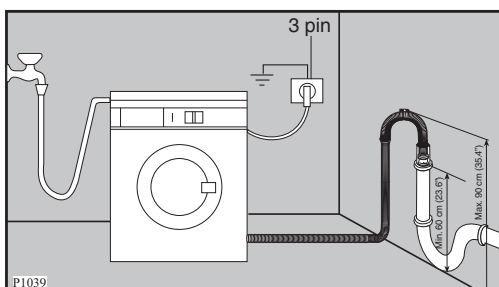

The drain hose may be extended to a maximum of 4 metres. An additional drain hose and joining piece is available from your local Service Force Centre. The joining piece must have an internal diameter of 18 mm.

If your drain hose looks like this (see below) you do not require the "U" piece". Just push the hose firmly into the standpipe.

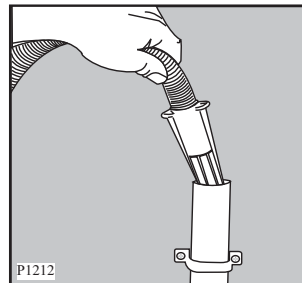

2. Onto a sink outlet spigot.

If the outlet spigot has not been used before, remove any blanking plug that may be in place.

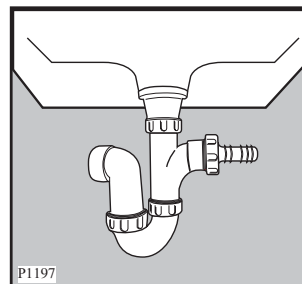

Push the drain hose onto the spigot and secure with a clip if required, ensure a loop is formed in the drain hose (see diagram) to prevent waste from the sink entering the washing machine.

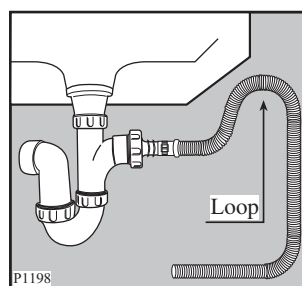

Important

Before connecting the machine to new pipework or to pipework that has not been used for some time, run off a reasonable amount of water to flush out any debris that may have collected in the pipes.

Levelling

Level the washing machine by raising or lowering the feet. The feet may be tight to adjust as they incorporate a self locking nut, but the machine **MUST** be level and stable (check diagonally).

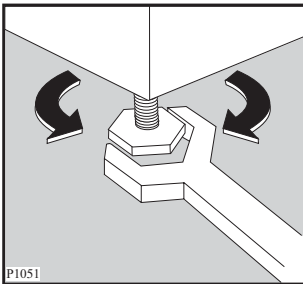

Any necessary adjustment can be made with a spanner. Accurate levelling prevents vibration, noise and displacement of the machine during operation.

Some vibration is inevitable, especially if mounted on a wooden floor.

Sprung wooden floors are particularly susceptible to vibration. For advice, consult a builder. If possible, always place the machine on a solid floor.

Special conditions

If the floor is carpeted or covered with crumbly or soft material, insert a rigid support base under the feet to prevent noise, vibration or displacement. The base should protrude a few centimetres beyond the edges of the machine.



Warning

The machine should **NOT** be placed on deep pile carpeting.

Note

Please ensure that when the appliance is installed it is easily accessible for the engineer in the event of a breakdown.

In the interest of the environment

Washing machines and dishwashers should be connected to the **FOUL** drainage system, the water will then be taken to a sewage works for treatment before being discharged safely into a river.

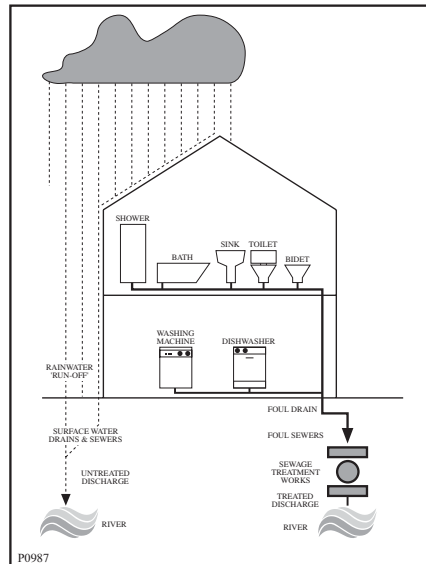

It is essential that these appliances are not connected to the surface water drainage system as this water is discharged directly into a river or stream and may cause pollution.

If you require any further advice please contact your local water authority.

Electrical connection

Any electrical work required to install this appliance should be carried out by a qualified electrician or competent person.



WARNING: THIS APPLIANCE MUST BE EARTHED.

The manufacturer declines any liability should this safety measure not be observed.

Before switching on, make sure the electricity supply voltage is the same as that indicated on the appliance's rating plate.

The rating plate is located at the top of the rim of the open door.

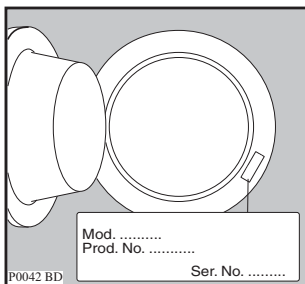

The appliance is supplied with a 13amp plug fitted. In the event of having to change the fuse in the plug supplied, a 13amp ASTA approved (BS1363/A) fuse must be used.

Should the plug need to be replaced for any reason, proceed as described below.

The wires in the mains lead are coloured in accordance with the following code:

- Green and Yellow - Earth
- Blue - Neutral
- Brown - Live

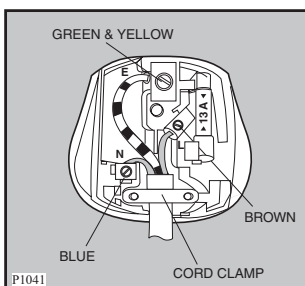

The wire coloured green and yellow must be connected to the terminal marked with the letter «E» or by the earth symbol \perp or coloured green and yellow.

The wire coloured blue must be connected to the terminal marked «N» or coloured black.

The wire coloured brown must be connected to the terminal marked «L» or coloured red.

Upon completion there must be no cut, or stray strands of wire present and the cord clamp must be secure over the outer sheath.

WARNING:



A cut off plug inserted into a 13 amp socket is a serious safety (shock) hazard. Ensure that the cut off plug is disposed of safely. Should the appliance power supply cable need to be replaced, this must be carried out by our Service Force Centre.

The power supply cable must be easily accessible after installing the appliance.

Important

If the mains supply cable is damaged it must be replaced; contact our warranty administrators on 0870 0107887 who will give you details for your local Service Force Centre.

Permanent connection

In the case of permanent connection it is necessary that you install a double pole switch between the appliance and the electricity supply (mains), with a minimum gap of 3mm between the switch contacts and of a type suitable for the required load in compliance with the current electrical regulations.

The switch must not break the yellow and green earth cable at any point.

The Control Panel

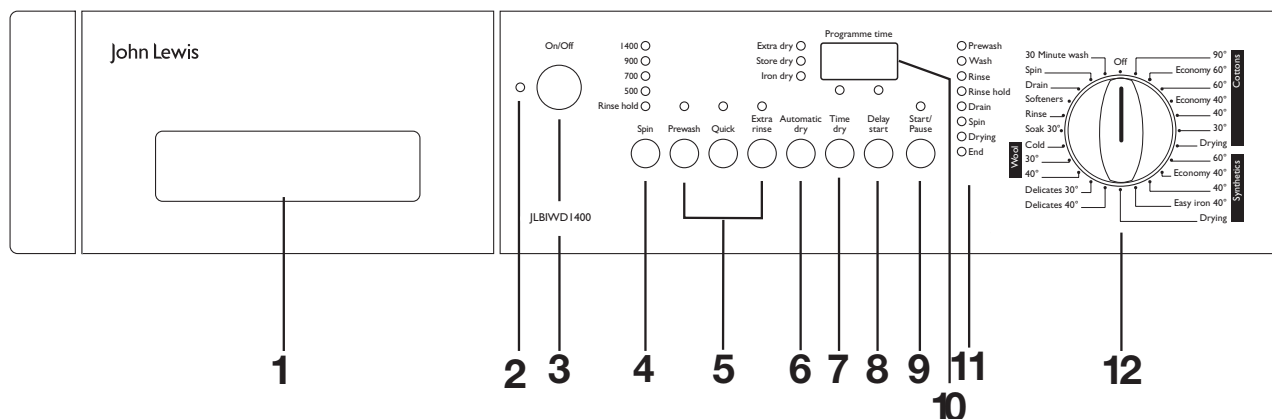

1 Detergent dispenser drawer

2 Mains-on light

This light comes on when the “On/Off” button is pressed, and goes out when it is pressed again.

3 “On/Off” button

Press this button to switch the machine on. Press it again to switch the machine off.

4 “Spin” button

Press this button repeatedly to change the spin speed, if you want your laundry to be spun at a speed different from the one proposed by the washer-dryer or to select position “Rinse hold”. The relevant light will light up.

Spin speed

The following speeds are available for the different fabrics:

- Cottons, linen: 500/700/900 max 1400 r.p.m.;
- Synthetics and wool: 500/700 max 900 r.p.m.;
- Delicates and “30 Minute wash”: 700 r.p.m.

“Rinse Hold” position

When RINSE HOLD option is selected, the last rinse water is not emptied out, to prevent the fabrics from creasing. When the programme has finished, the light of the “Start/Pause” button goes out, the light of the “Rinse hold” position and the “End” pilot light are alight to indicate that the water must be emptied out. The door is locked.

To empty out water there are 2 possibilities:

- Select programme “**Drain**” and then depress the “**Start/Pause**” button:
The water is emptied out without spinning.
- Select the Spin programme : reduce the spin speed by means of the relevant button and then depress the “**Start/Pause**” button.
The water is emptied out and the laundry is spun at the selected spin speed.

Important !

Before selecting the “Drain” or “Spin” programmes, the selector dial must be positioned on **Off** (cancelling).

The “**Rinse hold**” option CANNOT be selected for the automatic Washing & Drying programme.

5 “Option” buttons

Depending on the programme, different functions can be combined. These must be selected after choosing the desired programme and before depressing the “**Start/Pause**” button.

When these buttons are pressed, the corresponding pilot lights illuminate. When they are pressed again, the pilot lights go out.

If an incorrect option is selected, the pilot lights flash for about 2 seconds, an acoustic signal is heard and the message Err is displayed.

Press these buttons to select the following options:

- “**Prewash**”: select this option if you wish your laundry to be prewashed at 30°C max. before the main wash (**not available for Wool and “30 Minute wash”**).
The prewash cycle ends with a short spin at 650 rpm in programmes for cotton and synthetic fabrics, whereas in the programme for delicate fabrics the water is only drained. This option can be selected for heavily soiled laundry.

- **“Quick”**: select this option for laundry that is only slightly soiled in order to obtain a good wash result in a short time.

This option is **not** available with the Wool programmes, the Energy saving programmes **“Economy”** and **“30 Minute wash”**.

The washing time will be reduced according to the type of fabric and the selected temperature.

- **“Extra rinse”**: this option can be selected with all programmes, except the Wool programmes and **“30 Minute wash”**. The machine add 2 rinses for cotton and 1 rinse for synthetics and delicates.

This option is recommended for people who are allergic to detergents, and areas where the water is very soft.

6 “Automatic Dry” button

This button allows you to choose the required degree of drying for cottons and synthetics:

- Extra dry (only for cottons)
- Store dry (cottons and synthetics)
- Iron dry (only for cottons)

The drying time is automatically adjusted by the machine: the laundry will be dried to the selected degree of dryness.

7 “Time dry” button

If you wish to carry out a timed programme instead of an electronic programme push the button until the drying time you want appears in the display according to the fabrics (cotton or synthetics) you have to dry.

For **Cottons and Synthetics** you can select a drying time from 10 minutes to 130 minutes.

8 “Delay start” button

This button makes it possible to delay the starting of the programme 30 min - 60 min - 90 min, 2 hours and then by 1 hour up to a maximum of 23 hours. The delay you have selected is shown on the display for about 3 seconds; afterwards, the duration of the programme reappears.

You must select this option **after** you have set the programme and **before** you press the **“Start/Pause”** button.

The time value shown on the display will decrease by one unit every hour.

You can change the delay time at any moment, before you press the “Start/Pause” button.

If you have already pressed the “Start/Pause” button, and you wish to **cancel** the delay time, proceed as follows:

- set the machine to PAUSE by pressing the “Start/Pause” button;
- press the “Delay start” button until the symbol **“D”** is displayed.
- press the “Start/Pause” button again.

Important!

- The “Delay start” **cannot** be used with **“Drain”** or **“Spin”** programmes.

Note!

- With programme **“Soak 30”** the selected delay (**up to a maximum of 10 hours**) corresponds to the soak time of the laundry in the drum.
- The door will be locked throughout the delay time. If you need to open the door, you must first set the washer-dryer to Pause by pressing the **“Start/Pause”** button. After you have closed the door, press the **“Start/Pause”** button again.

9 “Start/Pause” button

This button has two functions:

- **Start**: after you have selected the desired programme and options, press this button to start the washer-dryer. The light above the button will stop flashing and remain lit. If you have selected a delay time, the countdown will begin and will be shown on the display.
- **Pause**: when you press this button again, the programme in progress is interrupted. The light above the button will start flashing. To restart the programme from the point at which it was interrupted, **press the button again.**

Important!

You must set the washer-dryer to Pause before you make any change in the programme in progress.

10 Display (Programme time)

The following pieces of information are shown on the display:

- **Reset/cancellation of the programme**
If the programme selector dial is turned to **“Off”** position, three blinking dashes are displayed. Now you can select a new programme.

(If, at the end of a washing cycle, the programme selector dial has not been turned to “Off” position, when you press the “On/Off” button to switch the machine on for the next washing, the display will show a blinking zero.)

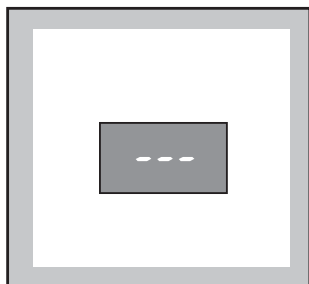

- **Duration of washing programme** in hours and minutes, after you have selected a programme (for example 2.05).



The duration is calculated automatically on the basis of the maximum recommended load for each type of fabric.

While the programme is running (after you have pressed the Start/Pause button), the displayed time value decreases by one unit every minute.



- **Selection of drying time** in minutes.

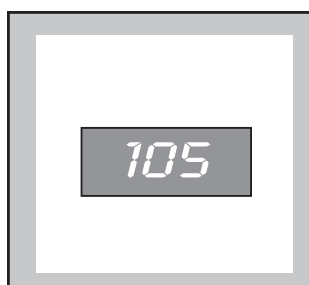

After starting the programme, the remaining time is updated every minute.

Important!

If you select a drying time longer than 55 minutes, after 3 seconds, the display will show it in hours and minutes (see the example below).

Example:

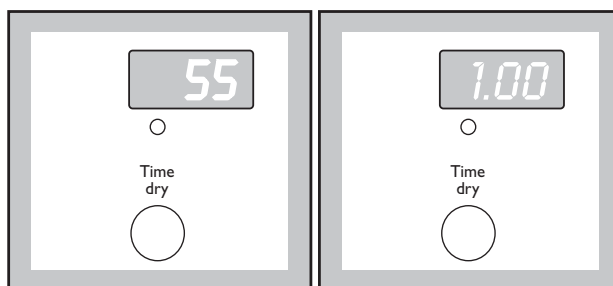

- **The washer-dryer has stopped with water in the tub**, when the “Rinse hold” option has been selected or at the end of the “Soak 30°”: this is indicated by a **flashing zero**.

- **The washer-dryer has completed the programme**: this is indicated by a **flashing zero**.

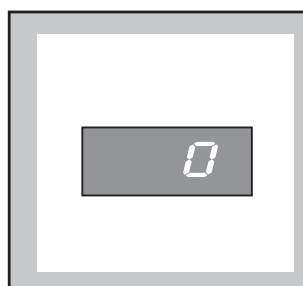

- **Delay start**, a time value indicated in hours (23 hours max) and selected by means of the relevant button.

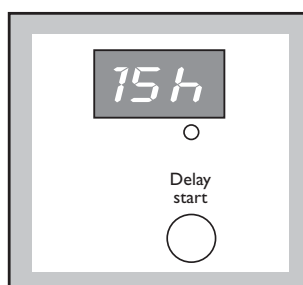

The delay time is displayed for 3 seconds, then the duration of the selected programme reappears. After you have pressed the Start/Pause button, the countdown is updated every hour, and, for the last two hours, every 30 minutes.

- **An incorrect option selection has been made:** this is indicated by the message **Err** when a function incompatible with the current programme is selected.

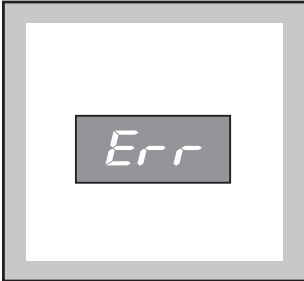

- **An alarm code** indicates a fault in the machine operation (see page 31, "Something Not Working").

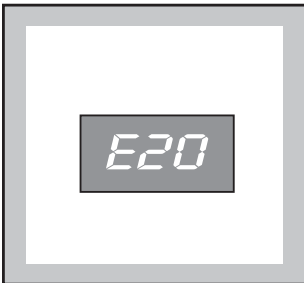

11 Programme phase indicator lights

When you select a programme, the lights relevant to the phases that form the programme light up.

After you have started the programme, only the light relevant to the phase that is currently being carried out will remain lit.

When the washing or drying programme has finished, the **“End”** light comes on and a flashing zero appears on the display. The light of the ‘Start/Pause is off.

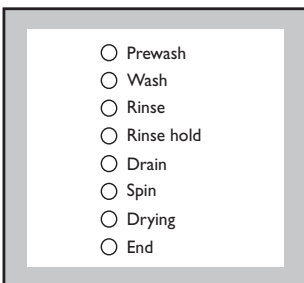

Important!

If you turn the programme selector dial to another programme when the machine is working, all the lights of the programme progress display will flash for about 2 seconds but the machine will not perform the new selected programme.

12 Programme selector dial

The programme selector dial is divided into the following sections:

- Cottons,
- Synthetics,
- Delicates
- Wool / Hand washing
- Special programmes from **“Soak 30”** to **“30 Minute wash”**
- Reset programme **“Off”**

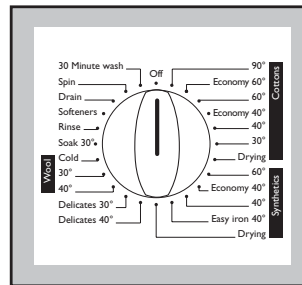

The selector dial can be turned either clockwise or anticlockwise to select the required wash and drying programme .

“Economy” position corresponds to an ENERGY SAVING programme and **“Cold”** to a cold wash.

Before setting the dial to any position ensure that the machine is turned to the **“Off”** position.

Important!

At the end of the programme the selector dial must be turned to position “Off”.

Programme information

Easy iron 40°

With this programme at 40°C it is possible to wash synthetic garments which must be ironed. The laundry is gently washed and spun to prevent the fabrics from creasing.

Max. load 1 kg.

Final spin speed 900 r.p.m.

Soak 30°

This is a special programme for heavily soiled laundry. The machine performs a soak of about 20 minutes at 30°C. At the end of the soak time the machine will stop automatically **with water left in the tub**. The display will show a flashing zero.

Pour the detergent for the soak programme into the compartment marked **[L]**.

This programme cannot be used for very delicate fabrics or Wool.

Before starting a new washing phase, it is necessary to empty out the water by:

- **Draining only:** turn the programme selector dial to “**Drain**” programme”. (Depress the “**Start/Pause**” button).
- **Draining and spin:** turn the programme selector dial to programme “**Spin**”, reduce the spin speed by means of the “**Spin**” button, and then depress “**Start/Pause**” button.

Important!

- At the end of the soak (after having emptied out the water) you can select the washing programme. First turn the programme selector dial to “**Off**”, then select the programme and depress the “**Start/Pause**” button.

Note!

- With programme “**Soak 30°**” it is possible to select the delay start only up to a maximum of 10 hours and it corresponds to the soak time of the laundry in the drum.

Rinse

With this programme it is possible to rinse and spin the garments which have been washed by hand. The machine performs 3 rinses, followed by a final long spin at the maximum speed.

Important!

The spin speed will automatically assume the setting for cotton items. If required, reduce the speed to the desired level by depressing the “**Spin**” button.

Softeners

Hand washed garments can be starched or softened with this programme.

The machine performs 1 rinse, followed by a final long spin at the maximum speed, which can be reduced by depressing the “**Spin**” button.

The final spin is foreseen only for cotton items as in the spin programme.

Drain

For emptying out the water of the programme “**Soak 30°**” or at the end of a programme with the “**Rinse hold**” option.

Turn first the programme selector dial to “**Off**”, then select the “**Drain**” programme and depress the “**Start/Pause**” button.

Spin

Separate long spin at the max speed for hand washed garments. It has to be used for cotton items. You can reduce the speed by means of “**Spin**” button to adapt it to the fabrics to be spun.

30 Minute wash

This is a complete programme that can be combined with the following options: Spin speed reduction, “**Rinse hold**” and “**Delay start**”.

To be used for laundry which is lightly soiled or which needs freshening up.

Max. load 2 kg.

Washing temperature 30 C.

Programme duration 30 minutes.

Final spin speed 700 rpm.

Off = Reset programme

To reset a programme turn the selector dial to “**Off**”. Now a new programme can be selected.

i Operating Sequence

Before the first wash, we recommend that you run a cotton cycle at 90°C, without any laundry in the machine, to remove any manufacturing residue from the drum and tub. Pour 1/2 a measure of detergent into the dispenser drawer and start the machine.

WASHING 5 KG OF WHITE COTTON AT 90°C

Suppose you have 5 kg of laundry to wash. It is white cotton and is suitable for high temperature washing.

1. Load the laundry

Open the door.

Place the laundry in the drum, one item at a time, shaking them out as much as possible.

Close the door.

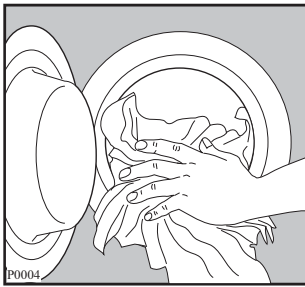

2. Measure out the detergent

Pull out the dispenser drawer until it stops. Measure out the amount of detergent required and pour it into the main wash compartment **III**.

If you wish to carry out the prewash or a soak programme, pour detergent into the appropriate compartment marked **I**.

3. Measure out the fabric softener

If required, pour fabric softener into the compartment marked **⊗**, without exceeding the «MAX» mark.

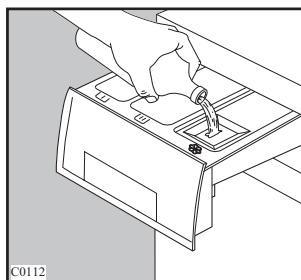
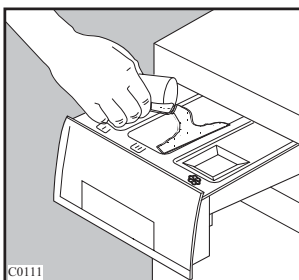

Close the drawer gently.

4. Switch the machine on

To switch the machine on, press the **ON/OFF** button: the mains-on light comes on. To switch the appliance off, depress the same button.

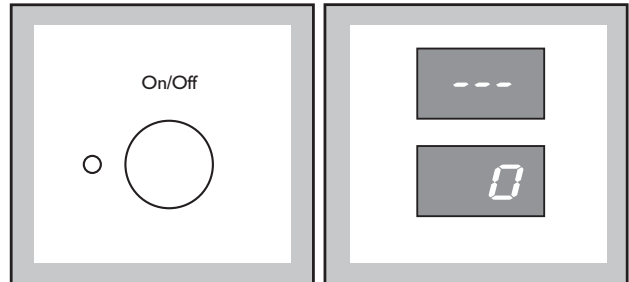

If the programme selector dial is on the “Off” (Reset) position, three flashing dashes will be displayed. If the programme selector dial is positioned on a wash programme, a flashing zero appears on the display.

5. Select the desired programme/temperature

Turn the selector dial to 90° programme. The lights relevant to the phases that form the programme will light up.

The display will show the duration of the selected programme, calculated on the basis of the maximum load for each type of fabric. The Start/Pause button light will start flashing.

If the load of laundry to be washed is small, at the beginning of the cycle the display will still indicate the duration relevant to the maximum load. The duration value will be gradually adjusted during the cycle.

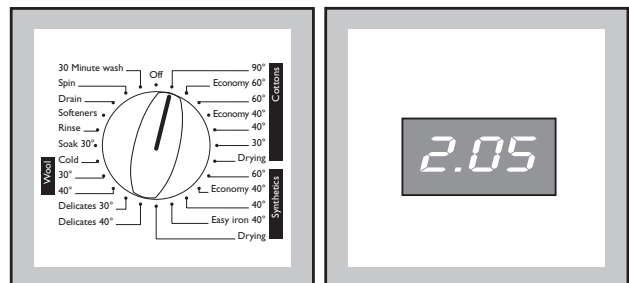

If your laundry needs a soak time, turn the programme selector dial to “Soak 30°” and then, before starting a washing cycle, empty the water as described in the “Soak 30°” paragraph.

6. Select the spin speed or the “Rinse hold” option

Press the “**Spin**” button repeatedly in order to select the desired spin speed or the “**Rinse hold**” option. If you select the “**Rinse hold**” option, the machine will stop at the end of the programme with the water still in the tub. The relevant light will light up.

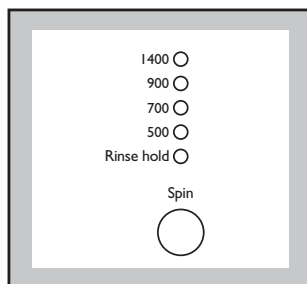

The selected delay time value (up to 23 hours) will appear on the display for 3 seconds, then the duration of the programme will appear again.

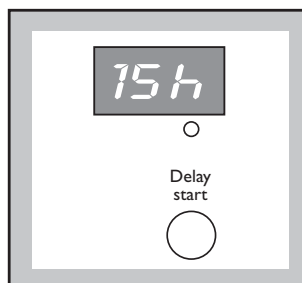

During this period it is possible to load other laundry: press the “**Start/Pause**” button. Open the door. Load the laundry. Close the door and press the “**Start/Pause**” button again.

7. Select the desired options

If your laundry is very dirty, it may be advisable to select the “**Prewash**” option.

If your laundry is only slightly soiled, select the “**Quick**” option.

If you wish the laundry to undergo an extra rinse, select the “**Extra Rinse**” option.

The relevant light illuminates.

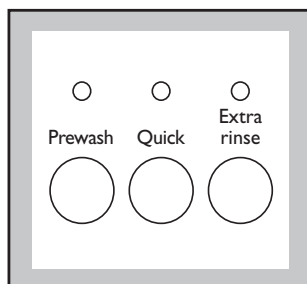

8. Select the “Delay start”

Before you start the programme, if you wish the start to be delayed, press the “**Delay start**” button repeatedly, or keep it pressed, to select the desired delay.

9. Start the programme

Press the “**Start/Pause**” button. The relevant light will stop flashing, and only the light relevant to the phase that is in progress will remain lit. The machine starts operating.

If you have chosen a delayed start, the washer dryer will begin the countdown.

The display will show the duration of the programme or the selected delay.

10. How to change an option or a programme during its cycle

It is possible to change any option before the programme carries it out.

Before you make any change, you must pause the machine by pressing the “**Start/Pause**” button.

Changing a running programme is possible only by **resetting it**.

Turn the programme selector dial to “**Off**” and then to the new programme position.

Start the new programme by depressing the “**Start/Pause**” button. The washing water in the tub will not emptied out.

11. How to interrupt a programme

Depress the **“Start/Pause”** button to interrupt a programme which is running, the corresponding light starts to flash. Depress the button again to restart the programme.

12. How to open the door during the cycle of a programme

You can open the door, after having set the washer-dryer to Pause, provided the following conditions exist:

- the machine is not in the heating phase beyond 55°C;
- the level of the water is not high;
- the drum is not turning.

If these requirements are met, when you pause the washer dryer, the door can be opened.

Should it not be possible to open the door, and should it be absolutely necessary to do so, switch the machine off by pressing the **“On/Off”** button.

After approximately 3 minutes, you can open the door.

Pay attention to the level and temperature of the water in the washer-dryer!

When you close the door and press the **“On/Off”** button again, the machine will resume the programme from the point where it had been interrupted.

13. End of programme

At the end of the programme, the machine stops automatically and displays a flashing zero.

The **“End”** light illuminates.

If the **“Rinse hold”** option has been selected, the light of the **“Start/Pause”** button goes out, a flashing zero appears on the display, the **“Rinse hold”** pilot light and the **“End”** light are on (the door will be locked) to indicate that the water must be emptied out before opening the door.

To drain the water or to spin see the paragraphs **“Draining only”** or **“Draining and spin”** on page 18.

Release of the lock is also indicated by the illumination of the **“End”** light.

Turn the programme selector dial to Reset **“Off”** and then press the **“On/Off”** button to switch the machine off.

Remove the laundry from the washer dryer.

Check whether the drum is completely empty, by rotating it with your hand. The purpose of this is to prevent any items of laundry from remaining accidentally in the drum, where they might get damaged in a subsequent wash (e.g. by shrinking) or bleed colour into another load of laundry.

We advise you to close the water supply tap and disconnect the plug from the socket.

Leave the door ajar in order to air the machine.

Drying

DRYING 2.5 KG OF COTTON

You have for example just machine-washed and spun at 1400 rpm 5 kg of laundry.

They are cotton fabrics of medium weight which you want to iron as soon as they are dry.

Remove the laundry from the appliance and divide the items to obtain two loads of approx. 2.5 kg each.

The water tap must be open and the drain hose must be positioned in the sink or connected to the drain pipe.

1. Load the laundry.
2. Depress the **“On/Off”** button to switch the machine on.
3. Turn the programme selector dial to the **“Drying”** programme in the **Cottons** sector.
4. If you wish to carry out the electronic drying, depress **“Automatic dry”** button until the light **“Iron Dry”** illuminates.

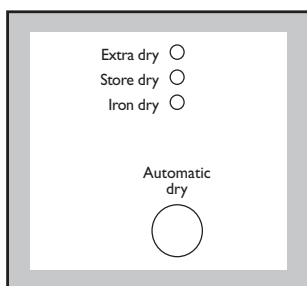

If you want a timed drying, depress the **“Time dry”** button until the time you want appears on the display (see page 19).

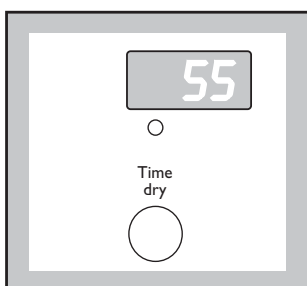

4. Press the **“Start/Pause”** button to start the programme.

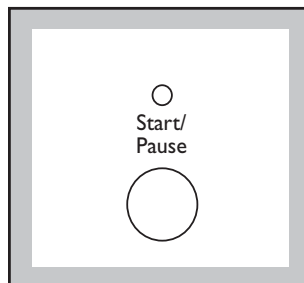

5. At the end of the programme turn the programme selector dial to **“Off”** and press the **“On/Off”** button again to switch the machine off.
6. Remove the laundry.

Note:

The programme time will automatically increase by up to 1 minute, this is quite normal.

AUTODRYING 1.5 KG OF SYNTHETICS

Warning! For NON-STOP programmes, it is also essential not to exceed the maximum load sizes of 2.5 kg for cotton and 1.5 kg for synthetics.

You intend to wash and dry automatically 1.5 kg of synthetics which do not need ironing.

Do not use a dosing device/ball when carrying out a washing & drying programme.

1. Load the laundry.
2. Add detergent and fabric softener.
3. Switch the machine on by depressing the **“On/Off”** button. Turn the selector dial to a programme for synthetics.
4. Select the wash programme/fabric and temperature.
5. Select the drying time or degree of drying.

6. Select the required options by means of the relevant buttons. If possible, do not select a spin speed lower than that proposed by the appliance to avoid a too long drying time so saving energy.

In any case the reduction of the spin speed is only possible after selecting drying. The lowest values you can select are the following:

- 900 r.p.m. for Cottons & Synthetics with electronic drying
- 900 r.p.m. for Cottons and 700 r.p.m. for Synthetics with timed drying

7. Start the programme by depressing the “**Start/Pause**” button.
8. At the end of the programme turn the programme selector dial to “**Off**” and depress the “**On/Off**” button again to switch the machine off.
9. Remove the laundry.

Important!

During drying the door can only be opened for the first 10 minutes and at the end of drying (after the cooling phase).

Washing and Drying Hints

Do **NOT** overload the machine. Weigh the laundry the first few times you use the appliance.

The average weights of the most common items are listed below as a guide:

1 000g = 1 kg

Sheet	700-1000 g
Pillow case	100-200 g
Tablecloth	400-500 g
Serviette	50-100 g
Tea towel	70-120 g
Linen hand towel	100-150 g
Towelling hand towel	150-250 g
Towelling bath towel	700-1000 g
Bath robe	1000-1500 g
Man's shirt	200-300 g
Apron	150-200 g

- Load the laundry loosely alternating large items with small ones.
- Sort the laundry according to the type of fabric, colour-fastness and how dirty it is.
- Avoid washing unhemmed or torn items as they may unravel.
- Before washing, empty all pockets of small objects which may have been left inside (coins, keys, screws etc). as these could damage the drain pump.
- When washing curtains, remove the hooks.
- Close poppers and zips and fasten loose buttons.
- It is essential to wash new coloured items separately when washing for the first time.
- When washing fabrics requiring different wash temperatures together, always select the lowest temperature.
- White items should not be washed with coloured items.
- Very small items (handkerchiefs, ribbons, socks etc) should be washed in a washing bag or a pillow case.
- Use a good quality detergent suitable for automatic washing machines.
- Use the correct quantities of detergent.
- For wool, use gentle detergent only in small quantities.
- Bleach is very corrosive; it should be used with care and kept out of reach of children.
- Some stains such as fruit, wine, grass, rust etc. are difficult to remove and should be treated before washing with specific products, which can be found in most household shops. In some cases it may help to soak the stain before washing with a special pre-soak product or biological detergent.
- If you have used the machine to wash, rinse or spin only non-colour fast garments, there may be dye left in the sump. To ensure any subsequent wash is not contaminated with the dye, select and carry out a rinse and spin programme, without any garments, to ensure that any dye is removed from the sump.
- Do not leave the damp laundry load in a heap too long before drying.
- Avoid drying dark clothes with light coloured fluffy items such as towels as these can attract the fluff.
- If you overdry the laundry, besides wasting energy, any subsequent ironing may become more difficult because the fabric could be heavily crumpled.
- Remove the laundry when the appliance has finished drying.
- To avoid a static charge when drying is completed, use either a fabric softener when you are washing the laundry or a fabric conditioner specifically for tumble dryers.
- Particularly delicate items such as synthetic curtains, woollen and silk, garments with metal inserts, nylon stockings, bulky garments such as anoraks, bedcovers, quilts, sleeping bags and duvets must not be machine dried.
- Garments padded with foam-rubber or materials similar to foam-rubber must not be machine dried; they represent a fire hazard.
- Also, fabrics containing residues of setting lotions or hair sprays, nail solvents or similar solutions must not be machine dried in order to avoid the formation of harmful vapours.
- For drying, follow the indications given on the manufacturer's labels.
 - May be tumble dried
 - Drying at high temperature
 - Drying at reduced temperature
 - Do not tumble dry

















Important!

As a dryer, the machine works on the condensation principle.

Therefore, the water tap must be open and the drain hose must drain water into a sink or into the drain pipe, even during the drying cycle.

Wash Care Symbols

Wash care labels inside garments recommend how to launder your clothes with the best results. The care labelling code is in line with care labelling used in the rest of Europe. The symbols used make it easy to select the correct programme on your washing machine.

WASHING SYMBOL	WASH ACTION	FABRIC
	Normal (Maximum)	White Cotton or Linen without Special Finishes
	Normal (Maximum)	Cotton, Linen or Viscose without Special Finishes Colourfast at 60°C.
	Reduced (Medium)	Nylon, Polyester/Cotton, Viscose with Special Finishes, Cotton/Acrylic Mix.
	Normal (Maximum)	Cotton, Linen or Viscose Colourfast at 40°C but not 60°C.
	Reduced (Medium)	Acrylics, Acetate, Triacetate, Wool mixes, Polyester/wool blends.
	Much Reduced (Minimum)	Wool, wool mixtures, Silks
	Hand wash only	Do not machine wash
BLEACHING		
	Chlorine bleach may be used	
IRONING		
	Hot iron	Cotton, Linen, Viscose
	Warm iron	Polyester mixtures, Wool
	Cool iron	Acrylic, Nylon, Polyester
DRY CLEANING		
	May be dry cleaned. Other letters and/or a bar beneath the circle will indicate the required process to the dry cleaner.	
TUMBLE DRYING		
	with high heat setting	
	with low heat setting	
	May be tumble dried	
	A cross through any symbol means «DO NOT»	



Important Notes

For best results, always use the dispenser drawer for dispensing detergents and liquid additives. Once the dispenser has been filled, close it by pushing it in gently. This is particularly important if you are using

fabric conditioner to avoid the conditioner entering the machine prematurely.

When using liquid detergent and a prewash programme, place the detergent into the correct compartment in the dispenser drawer, after the prewash has finished.

Washing programmes

Fabrics	Programme/ temperature	Type of laundry	Available options	Load	Consumptions*		
					Energy kWh	Water litres	Time min.
White cotton	90° Cottons	Sheets, household linen, towels, tablecloths	Spin red./Rinse hold Prewash Quick Extra rinse	5 Kg	1.9	52	142
White cotton	Economy 60° Cottons	Sheets, household linen, towels, tablecloths	Spin red./Rinse hold Prewash Extra rinse	5 Kg	0.85	49	136
White and coloured cotton	60° 40° - 30° Cottons	Fast coloured and non-fast items, for example hand towels, sheets, underwear, tablecloths, shirts, blouses	Spin red./Rinse hold Prewash Quick Extra rinse	5 Kg	1.2	49	121
Coloured cotton	Economy 40° Cottons	Coloured items, for example underwear, shirts, blouses	Spin red./Rinse hold Prewash Extra rinse	5 Kg	0.90	49	141
Synthetics	60° - 40°- Synthetics	Shirts, blouses, underwear, mixed fabrics	Spin red./Rinse hold Prewash Quick Extra rinse	2 Kg	0.85	41	89
Synthetics	Economy 40° Synthetics	Shirts, blouses, underwear, mixed fabrics	Spin red./Rinse hold Prewash Extra rinse	2 Kg	0.5	41	89
Synthetics	Easy iron 40° Synthetics	Shirts, blouses, underwear, mixed fabrics	Spin red./Rinse hold Prewash Quick Extra rinse	1 Kg	0.35	39	102
Delicates	30° - 40° Delicates	Acrylic, polyester items, curtains, duvets	Spin red./Rinse hold Prewash Quick Extra rinse	2 Kg	0.55	58	58
 Wool 	40° - 30° - Cold Wool	Garments bearing the “ Pure new wool, non-shrink, machine washable” or “Hand wash” label	Spin reduction/ Rinse hold	1 kg	0.4	58	57

The “**Cottons Economy 60°**” programme (white cottons) is the reference programme for the data entered in the energy label, in compliance with EEC 92/75 standards.

* This data is given purely as an indication: the consumption values may vary in relation to the quantity and type of laundry, the temperature of the water supply and the ambient temperature. The data refers to the highest temperature provided for each programme.

Washing programmes

Programme	Programme description	Available options	Load	Consumptions*		
				Energy kWh	Water litres	Time min.
Soak 30°	Soak for 30 minutes at 30°C		5 Kg	0.3	18	19
Rinse	3 rinses Long spin at the max speed	Spin reduction/ Rinse hold Extra rinse	5 Kg	0.1	40	47
Softeners	1 rinse with liquid additive Long spin at max. speed	Spin reduction/ Rinse hold	5 Kg	-	16	23
Drain For emptying out after the programme "Soak 30°" or at the end of a programme with " Rinse hold " option	Water draining	-	5 Kg	-	-	2
Spin	Drain and long spin at max. speed	Spin reduction	5 Kg	-	-	10
30 Minute wash Short cycle for lightly soiled fabrics	Wash at 30°C 2 rinses Short spin	Spin reduction/ Rinse hold	2 Kg	0.3	40	30
Off (Reset)	For cancelling the programme which is running		-	-	-	-

Drying Programmes

Timed drying

Degree of drying	Type of fabric	Max. load	Spin speed	Drying time mins
Extra dry Ideal for towelling materials	Cotton and linen (bathrobes, bath towels, etc.)	2.5 kg	1400	105-115
		1 kg	1400	50-60
Store dry (*) Suitable for items to put away without ironing	Cotton and linen (towels, T-shirts, bathrobes)	2.5 kg	1400	95-105
		1 kg	1400	40-50
	Synthetics and mixed fabrics (jumpers, blouses, underwear, household linen)	1.5 kg	900	100-110
		1 kg	900	55-65
Iron dry Suitable for ironing	Cotton and linen (sheets, tablecloths, shirts, etc.)	2.5 kg	1400	65-75
		1. kg	1400	30-35

(*) The STORE DRY drying programme for cotton is the reference programme for the Energy Label data, in compliance with EC directive 92/75.

Maintenance and Cleaning

Before any maintenance or cleaning is carried out you must **DISCONNECT** the appliance from the electricity supply.

Descaling

The water we use normally contains lime. It is a good idea to periodically use a water softening powder in the machine. Do this separately from any laundry washing, and according to the softening powder manufacturer's instructions. This will help to prevent the formation of lime deposits.

After each wash

Leave the door open for a while. This helps to prevent mould and stagnant smells forming inside the appliance. Keeping the door open after a wash will also help to preserve the door seal.

Maintenance Wash

With the use of low temperature washes it is possible to get a build up of residues inside the drum. We recommend that a maintenance wash be performed on a regular basis.

To run a maintenance wash:

- The drum should be empty of laundry.
- Select the hottest cotton wash programme.
- Use a normal measure of detergent, must be a powder.

External cleaning

Clean the exterior cabinet of the appliance with soap and water only, and then dry thoroughly.

Cleaning the dispenser drawer

The washing powder and additive dispenser drawer should be cleaned regularly.

Remove the drawer by pressing the catch downwards and by pulling it out. Flush it out under a tap, to remove any traces of accumulated powder. To aid cleaning, the top part of the additive compartment should be removed.

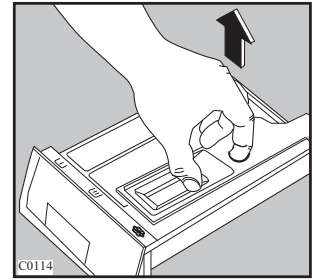
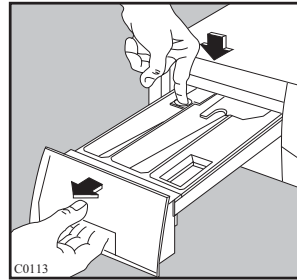

Cleaning the drawer recess

Having removed the drawer, use a small brush to clean the recess, ensuring that all washing powder residue is removed from the upper and lower part of the recess. Replace the drawer and run the rinse programme without any clothes in the drum.

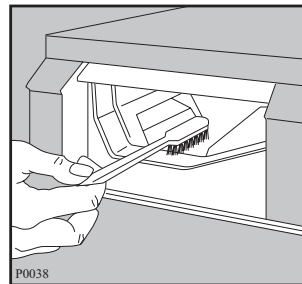

Cleaning the filter

The water drain filter

A clean filter is important for the correct functioning of the machine, and should therefore be cleaned after every washing programme.

Place a container under the filter to catch any spillage. If the filter is blocked and the machine is unable to drain you will need to drain the water manually from the machine at this stage. To do this, unhook the drain hose from the standpipe or sink and hold the end of the hose over a bowl on the floor. The water should drain by gravity into the bowl. When the bowl is full, hook the hose back up and empty the bowl. Repeat the procedure until water stops flowing out.

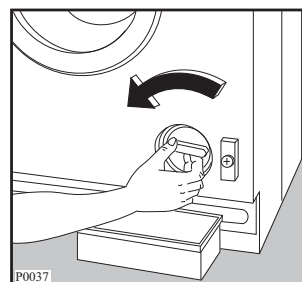

Unscrew and remove the filter.

Clean carefully under a fast running tap.

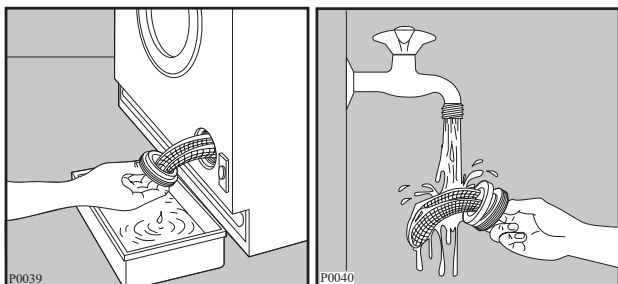

Warning

When the appliance is in use and depending on the programme selected there can be hot water in the pump. Never remove the pump cover during a wash cycle, always wait until the appliance has finished the cycle, and is empty. When replacing the cover, ensure it is securely retightened so as to stop leaks and young children being able to remove it.

Cleaning the water inlet filter

If your water is very hard or contains traces of lime deposit, the water inlet filter may become clogged. It is therefore a good idea to clean it from time to time. Turn off the water tap.

Unscrew the water inlet hose.

Clean the filter using a hard bristle brush.

Tighten up the inlet hose.

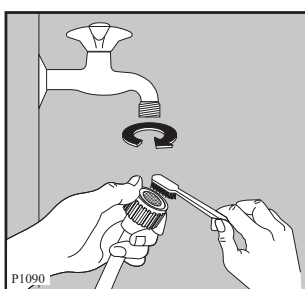

The dangers of freezing

If the machine is exposed to temperatures below 0°C, certain precautions should be taken.

- Turn off the water tap.
- Unscrew the inlet hose.
- Unhook the drain hose from the rear support and position the end of this hose and that of the inlet hoses in a bowl. Run the draining programme.

To do this:

- Switch the machine on
- Select the “**Drain**” programme
- Press “**Start/Pause**” button
- Disconnect the appliance .
- Screw the inlet hose and reposition the drain hose.
- When you intend to start the machine up again, make sure that the room temperature is above 0°C.

Emergency emptying out

If the water is not discharged, proceed as follows to empty out the machine:

- pull out the plug from the power socket;
- close the water tap;
- if necessary, wait until the water has cooled down;
- open the filter;
- place a bowl on the floor under the filter.
- slightly loosen the filter to let the water come out slowly;
- clean the filter if necessary as previously described;
- screw the filter again and close the door.

Something Not Working

Certain problems are due to lack of simple maintenance or oversights, which can be solved easily without calling out an engineer. Before contacting your local Service Force Centre (see page 33 , Service and Spare Parts), please carry out the checks listed below.

IMPORTANT: if you call out an engineer to a fault listed below, or to repair a fault caused by incorrect use or installation, a charge will be made even if the appliance is under guarantee.

During machine operation it is possible that the “End” light starts to flash, one of the following alarm codes appears on the display and in the same time the buzzer sounds:

- *E10* : problem with the water supply
- *E20* : problem with water draining
- *E40* : door open

Once the problem has been eliminated, press the “Start/Pause” button to restart the programme. If after all checks, the problem persists, contact your local Service Force Centre.

Symptom	Solution
The machine does not start	<ul style="list-style-type: none"> ● The door has not been closed. (<i>E40</i>) ● The plug is not properly inserted in the power socket. ● There is no supply at the socket. ● The main fuse or the fuse in the plug has blown. ● The “Start/Pause” button has not been depressed. ● The “Delay start” option has been selected.
The machine does not fill	<ul style="list-style-type: none"> ● The water tap is closed. (<i>E10</i>) ● The filter in the inlet hose is blocked. (<i>E10</i>) ● The inlet hose may be squashed or kinked. (<i>E10</i>) ● The door has not been closed. (<i>E40</i>)
The machine fills then empties immediately	<ul style="list-style-type: none"> ● The end of the drain hose is too low. ● The end of the drain hose is submerged in water. ● There is no vent in the end of the drain hose.
The machine does not empty and/or does not spin	<ul style="list-style-type: none"> ● The drain hose may be squashed or kinked. (<i>E20</i>) ● The drain filter may be blocked. (<i>E20</i>) ● The “Rinse hold” option has been selected. ● The drainage system pipes are blocked. ● The programme “Soak 30”, which ends with water left in the tub, has been selected. ● The wash load is unbalanced: redistribute the clothes inside the drum to allow the machine to spin.
There is water on the floor	<ul style="list-style-type: none"> ● Too much detergent or unsuitable detergent has been used (creates too much foam). ● Check whether there are any leaks from the inlet hose fittings. It is not always easy to see this as the water runs down the hose; check to see if it is damp. ● The drain hose may be damaged or not securely positioned. ● The filter has not been fully screwed in after cleaning.

Symptom	Solution
Unsatisfactory washing results	<ul style="list-style-type: none"> ● Too little detergent or unsuitable detergent has been used. An insufficient amount of detergent leaves the laundry looking grey and causes lime scale to form. ● Stubborn stains have not been treated prior to washing ● The correct wash programme/temperature has not been selected. ● Too much laundry has been placed in the drum.
The machine vibrates when spinning	<ul style="list-style-type: none"> ● The internal packing has not been removed. ● The machine is in contact with the wall or furniture. ● The machine is not level and stable (check diagonally). ● The washing load is badly distributed in the drum. ● Maybe there is very little laundry in the drum.
The door will not open	<ul style="list-style-type: none"> ● The water level is above the bottom edge of the door. ● The machine is heating the water or drying the laundry. ● The drum is turning.
Spinning starts late or the machine does not spin	<ul style="list-style-type: none"> ● The electronic balance control device has cut in because the laundry is not evenly distributed in the drum. The laundry is redistributed by reverse rotation of the drum. This may happen several times before the unbalance disappears and normal spinning can resume. If, after few minutes, the laundry is still not evenly distributed in the drum, the machine will not spin. In this case, redistribute the load manually and select the spin programme.
The machine makes an unusual noise	<ul style="list-style-type: none"> ● The machine is fitted with a type of motor which makes an unusual noise compared with other traditional motors. This new motor ensures a softer start and more even distribution of the laundry in the drum when spinning, as well as increased stability of the machine.
No water is visible in the drum	<ul style="list-style-type: none"> ● Machines based on modern technology operate very economically using very little water without affecting performance.
The machine does not dry or does not dry properly	<ul style="list-style-type: none"> ● The drying time or degree of drying has not been selected ● The water tap is not turned on (<i>E10</i>) ● The drain filter is clogged (<i>E20</i>) ● The machine is overloaded ● The selected drying time or degree of dryness was not suitable for the laundry.

Service & Spare Parts

In the event of your appliance requiring service, or if you wish to purchase spare parts, please contact our extended warranty administrators by telephoning:

0870 01 07887

They will give you details for your local Service Force Centre.

Service Force are the appointed national appliance repair agents responsible for warranty repairs to this appliance.

Before calling out an engineer, please ensure you have read the details under the heading "Something Not Working".

When you contact the Service Centre you will need to give the following details:

1. Your name, address and post code
2. Your telephone number
3. Clear and concise details of fault
4. The model and serial number of the appliance (found on the rating plate - see picture)
5. Your washer-dryer is covered by a 3 year parts and labour guarantee (see separate details given at point of sale). Please retain your purchase receipt safely for the service .

Please note that a valid purchase receipt is required for in-guarantee service calls.

